

Delta Membranes

Cavity Drain Waterproofing Type C Systems

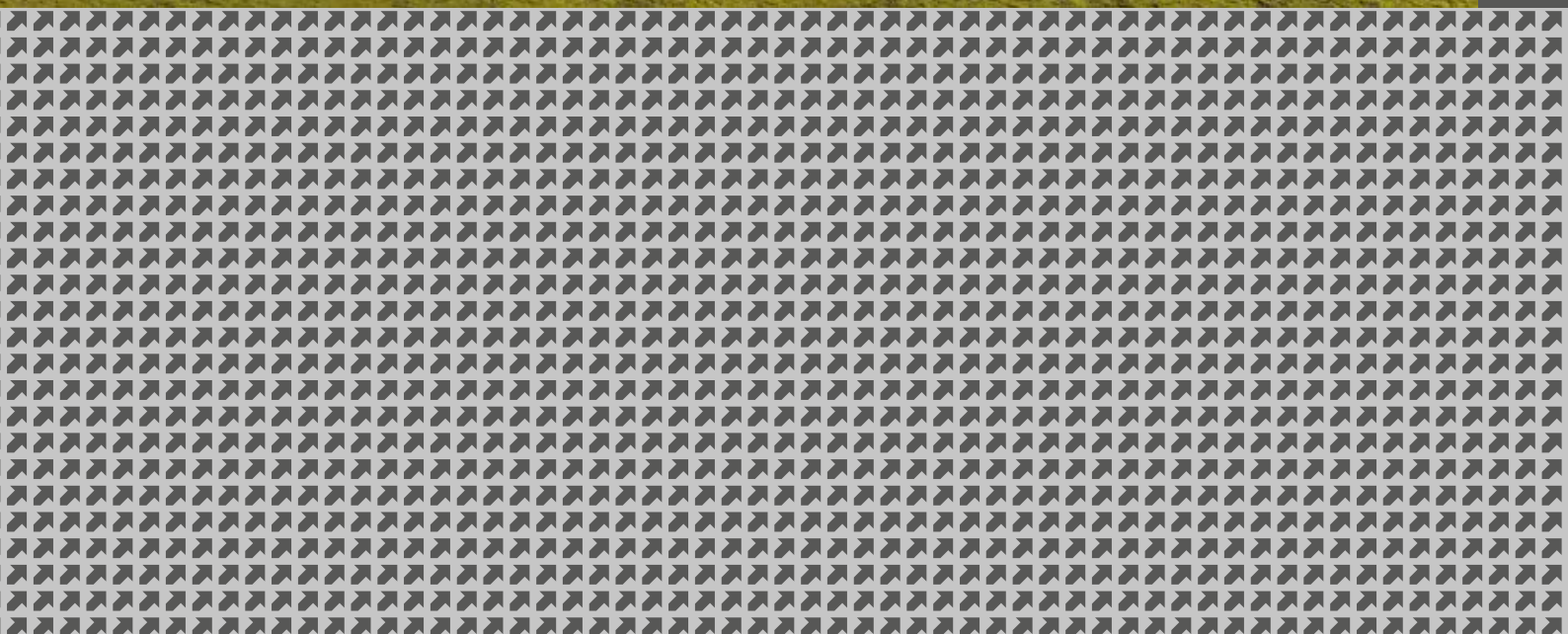

CONTENTS



About Us	03
Types of Waterproofing	04
British Standard BS 8102:2022	05
Design and Build Philosophy	06
Type C, Cavity Drainage Membranes	12
Type C, Ancillaries	20
Drainage Design	22
Perimeter Drainage Channel	24
Drainage Channel and Accessories	26
Submersible Pumps	28
Packaged Pumps	30
High Water Level Alarms	32
Battery Backups	33
Delta Bespoke 800 Series Groundwater	36
Delta Bespoke 800 Series Foul	37
Delta 1000 Series - Delta Pluto Package Pumping Station	38
Delta 1000 Series - Delta Bespoke Mercury Foul	39
Technical Drawings	40



ABOUT US

Delta Membranes Systems Limited

Delta Membrane Systems Limited is a manufacturer and provider of specialist structural waterproofing solutions, covering Types A, B and C waterproofing, combination waterproofing, damp proofing, basement drainage, flood resilience and ground gas protection.

We aim to deliver excellence by putting our customers at the heart of everything we do.

Delta unites innovative products with highly skilled waterproofing design specialists. Our in-house team of technical consultants support our clients in providing comprehensive, reliable, and expert advice, identifying, and mitigating risk and establishing opportunities for added value.

Our projects include commercial and residential structures, new-build and refurbishment, housing developments and civil infrastructure. Our technical consultants cater to a diverse client base, including architects, developers, contractors, sub-contractors, engineers, and homeowners all centred on latest industry guidance, current legislation, standards, and best practice.

Delta proudly supports the Women of Waterproofing Networking Group. An independent networking group that promotes gender equality in the waterproofing sector, seeking to inspire, retain and attract females.

Delivering world-class solutions, Delta is an impeccable partner on every project.



INNOVATION MANUFACTURER DESIGN SOLUTION



We have a dedicated, multi-disciplinary team creating innovative, robust, and reliable waterproofing solutions. We strive for excellence and manufacturing synergy, utilising each team member's individual skills and own unique approach on design, collaborating to achieve exceptional results.



The Delta Specification team works with architects, designers, contractors, and engineers. Our team provides full consultation services, including CSSW Specification Reports. We offer advice on how Delta specifications can promote the successful outcome of any project.



With extensive experience in the field of structural waterproofing, we draw upon knowledge and expertise to offer totally flexible on-site support. As part of our commitment to innovate through the development of best practice, our on-site support will complement any existing design and installation team. We aim to help support and develop the skills of your technicians and, if required, will also provide bespoke onsite training for your technical teams.

Types of Waterproofing

There are many different approaches to structural waterproofing. The construction methods will in part contribute to the specification of types of waterproofing systems along with a full assessment of risk based on-site investigation, which will determine the overall structural waterproofing strategy.

Structural waterproofing falls into 3 types

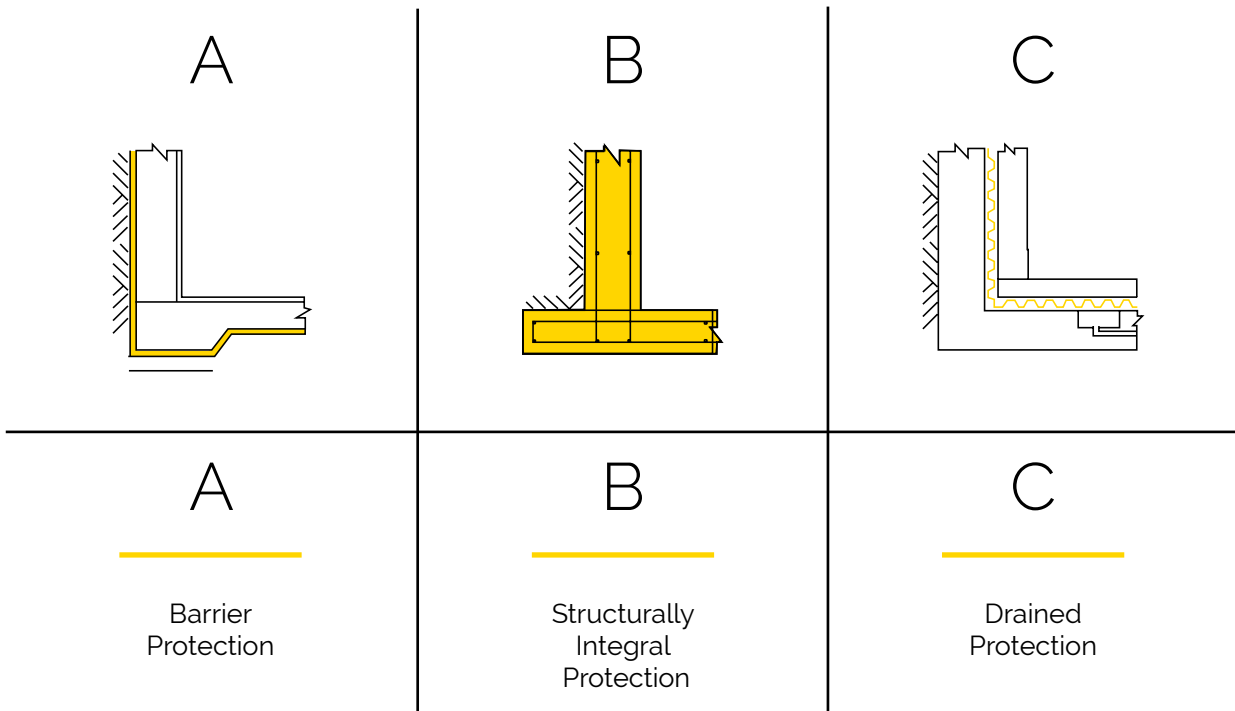

BASEMENT DRAINAGE

A key component of a Type C, Drained Protection System is the drainage system. Often referred to in the industry as 'basement drainage'.

Type C, Cavity Drained Protection systems are water management systems. The Type C System manages water that penetrates the external shell of a structure by collecting it in a cavity formed between the external wall and an internal lining/wall. There is permanent reliance on this cavity to collect ground water seepage and direct it to a suitable discharge point. For Type C, Cavity Drainage Systems to function as intended, water ingress should be removed by a gravity drain/gravity drainage or mechanical pumping.



BS 8102:2022 gives recommendations and provides guidance on methods of dealing with and preventing the entry of water from external sources into structures that are partly or wholly below ground level.

It covers the use of:

- a) Waterproofing barrier materials applied to the structure
- b) Structurally integral watertight construction
- c) Drained cavity construction

Those responsible for the overall waterproofing design should be identified at the planning stage or as early as possible. All decisions made by others that might have an impact on the waterproofing design should be brought to the attention of the waterproofing specialist, design team and installing contractors. Final decisions and any recommendations should be approved by those taking overall responsibility for the design of the waterproofing.

BS 8102 further covers (but is not limited to):

- Types of construction
- Water table classification
- Scope and limitations
- Site evaluation
- Water-resistant design philosophies
- General construction issues
- Remedial measures



British Standard 8102:2022 (Protection of Below Ground Structures Against Water Ingress. Code of Practice).

NHBC Chapter 5.4

gives guidance on technical requirements for the waterproofing of basements and other structures below, or near to ground level, (these include but are not limited to):

- Design standards
- Compliance
- Statutory requirements
- Provision of information
- Waterproofing
- Ground conditions
- Structural stability
- Design considerations
- Thermal insulation and vapour control layers
- Waterproofing systems and surface finishes
- Rainwater drainage
- Handling, storage and protection

DESIGN AND BUILD PHILOSOPHY

Type C

One of the primary requirements of waterproofing design is the prevention of water ingress and the management of water and water vapour movement through and out of a structure. This ethos is identical for any below ground areas of a structure.

Type C waterproofing protection manages water that penetrates the external shell of a structure by collecting it in a cavity formed between the external wall and an internal lining/wall. There is permanent reliance on this cavity to collect ground water seepage and direct it to a suitable discharge point.

A Waterproofing Designer's philosophy defines what they wish to accomplish in the design of their waterproofing system and which principles they will use to do so. Fully assessing the risks and identifying a robust and suitable design philosophy is an important aspect when designing a continuous system, as this will not only directly impact in how users install the system but also in future maintenance which will directly impact on the property owner.

Continuity is crucial for successful construction and waterproofing. BS 8102:2022 places additional emphasis on good planning, correct sequencing and that site management processes are in operation.

Waterproofing measures should be designed on the basis that during the life of the structure water might come against any part of the structure that is at or below ground level or is earth retaining. Waterproofing should therefore be continuous.

To ensure waterproofing designs are durable and fit for purpose, correct detailing and implementation of penetrations are an important discipline. Whether pre- or post- construction these should be carefully detailed to minimize the risk of water ingress.

As part of a waterproofing solution Designers are required to include assessment of remedial treatment of their designs and be included as a contingency measure. As with all elements of construction, workmanship and quality control are crucial in designing for success.

As with all elements of construction, workmanship and quality control are crucial in designing for success.

BS 8102:2022 recognises the importance of transparency between manufacturer and installer in verifying compatibility between products.

A robust quality assurance process/integrity testing should always be conducted to avoid any potential mistakes.

Considerations for effects of climate change, burst water mains, flooding, etc. should be included in all designs.

Type C systems within the industry are considered one of the safest forms of waterproofing.

Assessing Risk/Reducing Risk and Substrate Preparation



British Standard 8102:2022 (Protection of Below Ground Structures Against Water Ingress – Code of Practice) provides guidance and recommendations for methods of dealing with and preventing the entry of water from external sources into structures that are partly or wholly below ground level (earth retaining).

It covers the use of:

- Waterproofing barrier materials applied to the structure
- Structurally integral watertight construction
- Drained cavity construction

Those responsible for the overall waterproofing design should be identified at the planning stage or as early as possible. All decisions made by others that might have impact on the waterproofing design should be brought to the attention of the waterproofing specialist, design team and installing contractors. Final decisions and any recommendations should be approved by those taking overall responsibility for the design of the waterproofing.

A risk assessment should be carried out to include desk study, risk assessment of potential effects of climate change along with water table classification, inclusion of ground gas contamination and external risk. The assessment of risk should provide the justification for the proposed waterproofing design.

Design and construction should be kept as simple as possible. With consideration to floor/ceiling/wall junction(s), which should be designed to resist passages of water ingress. The joints between ceilings/walls/floors are particularly vulnerable areas and care should be taken to ensure these joints are sealed to ensure that no water or moisture can penetrate.

Substrates should be properly assessed and prepared. Substrates should be clean, crack-free, sound, free of substances (such as grease, bitumen, dust, paint or adhesive residues, etc.) and must comply with the relevant standards.

DESIGN AND BUILD PHILOSOPHY

Detailing

Correct detailing can successfully provide protection to the waterproofing solution.

Categories that fall into detailing are:

- Service penetrations
- Wall/floor junctions
- Soffit wall joints
- Level changes
- Internal/External thresholds
- Linking to DPC
- Product compatibility
- Continuity
- Complex geometries

Use of correct materials for the specific site, applied in accordance with the manufacturer's instructions.

Consequences of inadequate detailing can be:

- Water ingress
- Disruptive remedial works
- Separation of the structural elements/elevations
- Worst-case scenario, structural collapse

To design out defects in respect of service penetrations it is recommended to bring the services into the building from above ground, service ducts or light wells can allow for services to be brought in from above. Of course, this is not always possible and should be discussed with the waterproofing design team/manufacturer to ensure correct detailing to seal such elements to be watertight and durable.

Detailing can be complex, in all cases details that penetrate a waterproofing system should be detailed and installed in accordance with the manufacturer's guidelines.

Careful detailing plays an important role in waterproofing design. Whichever form of waterproofing system is considered or combination of systems, consideration should be given to the correct detailing to design out potential failures.

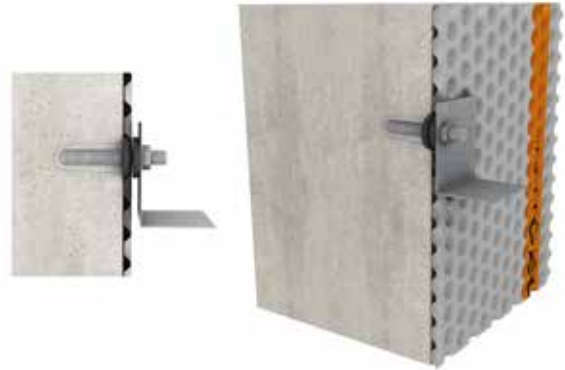

Fire Protection/Euroclass

Fire Protection/Euroclass

When designing an appropriate waterproofing system, a Waterproofing Design Specialist will always take into consideration the end use of a space to ensure they have designed a suitable solution that will meet both standards and user requirements along with functionality.

When designing the most appropriate waterproofing system to any given situation, various design factors will need addressing such as (but not limited to), final use of the building, the grade of waterproofing requirement under the British Standard, structural considerations based on the form of construction and in some cases, satisfying the requirements of building warranty providers.

By keeping a proactive approach to designing a system that meets current building regulations there is also an opportunity of future proofing designs to maximise the whole value of the project in the face of unpredictable, ongoing change.

Euroclass Fire Ratings

Reaction to fire, often called the Euroclass system gives building products a classification. The 'Reaction to fire' classes test three properties of the building material: spread of fire, smoke intensity and burning droplets. Most building materials sold on the European market must be assigned a file indicating its fire resistance based on a Euroclass rating system. There are 7 Euroclasses of reaction to fire performance for construction products which extend from A1 to F.

Euroclasses and the target safety level	
Euroclass	Target safety level
A1	No contribution to fire even under fully developed fire conditions
A2	Only negligible contribution to fire even under fully developed fire conditions; no spread of fire from the area of the primary fire in the fire development phase
B	In the fire development phase, no spread of fire from the area of the primary and very limited contribution to the fire
C	Under the conditions of a fire in the development phases, very limited spread of fire and limited energy release and ignitability
D	Under the conditions of a fire in the development phases, limited spread of fire and acceptable energy release and ignitability
E	In the case of a very small fire (match flame) acceptable reaction to fire (ignitability, flame spread)
F	No requirements concerning the reaction to fire
Additional assessment classes for smoke development and burning droplets/particles	
Smoke development	s3 (there are no restrictions regarding smoke development) s2 (the fully released amount of smoke, and the rise in smoke development are restricted) s1 (stricter criteria than for s2 must be fulfilled)
Burning droplets/particles	d2 (there are no restrictions) d1 (burning droplets not longer than the defined time) d0 (dripping fire debris is not permitted)



Maintainable Designs

Delta's Type C Waterproofing System should be designed and installed as a maintainable water management system. This is highlighted as a key requirement in BS 8102:2022, all components of the system should be accessible for both inspection and maintenance.

Flood Testing/Integrity Testing

The integrity of the waterproofing system should be checked and inspected on installation and immediately upon completion. If there is a delay before final handover or the laying of permanent coverings, a second test is strongly recommended. Test objectives should be decided upon prior to the method of testing.

Registered Installer Network

As manufacturers of quality systems, it is imperative to work with quality installation companies. At Delta, we pride ourselves that we've built a team of highly qualified, reliable, specialist Registered Installers.

Delta Registered Installers Network are an elite group of experienced Delta System installers who share our values – a dedication to quality, authenticity, and exceptional customer services.

Our Delta Registered Installer Partners all have extensive experience of working with and installing Delta Systems, meaning you can be confident of a quick, efficient installation, carried out with the minimum of disruption and fuss. All Delta Registered Installers adhere to a strict criteria and are required to attend training as well as demonstrating quality of workmanship before accreditation of the Registered Installer title, resulting in a meaningful scheme that provides unrivalled technical excellence.

Commissioning and Servicing of Basement Drainage System

Immediately after the installation of the Type C, Cavity Drainage System, drainage channels and sump pumps should be tested. A requirement in BS 8102:2022 is for pumping devices to be checked, tested and fully commissioned by a suitably qualified engineer. Requirements for servicing and maintenance should be incorporated in both the design and upon completion should be included in the Operational and Maintenance Manual. A first inspection should be carried out on completion of the installation of the Type C system at handover and commissioning. It is recommended a second inspection should be within the first 3 months after installation.

Servicing of sump pump systems should be carried out no less frequently than annually. We recommend pumps running frequently due to higher water tables, water drainage, or weather conditions should be examined more frequently, we recommend every 6 months.

Delta Pumps Registered Installer Network

Sump pump systems are a critical part of a Type C Drained protection systems and therefore must be maintained. We recommend a qualified pump engineer examines and services the pump equipment every 12 months. Pumps running frequently due to a higher water table, water drainage, or weather conditions should be serviced more frequently (every 3-6 months) subject to levels of water ingress.

Sump pumps, being mechanical devices, may fail if not maintained which could lead to a flooded basement and costly repairs. Regular servicing of sump pumps will improve efficiency and extend the life of the pumps.

All sump pumps will require commissioning along with regular maintenance and servicing. All Delta pump systems can be commissioned, maintained and serviced by a Delta Registered Pump Servicing provider or installing contractor.

Delta Registered Pump Servicing Network provider can offer a 5-year extended warranty period on Delta Pumps (subject to terms and conditions). Extended warranties are a way of getting extra protection for Delta Pumps in addition to the standard warranty offered.

Delta Registered Pump Servicing Network providers will register the Delta Pump for an Extended Manufacturer's Warranty.

Guarantees

Delta Membrane Systems Limited offer a 30-year Product Guarantee on membranes, seals, and fixings when a Delta Registered Installer has installed a Delta, Type C Cavity Drainage System.



Additional Information

For additional information or assistance please contact:

Delta Membrane Systems Limited
01992 523 523 or email info@deltamembranes.com

Free Lime

Free lime and mineral salts leaching from concrete walls and floors are one of the commonest causes of failure of a Type C, Drained Protection System.

Free lime and mineral salts leach from new construction by groundwater ingress, this then deposits itself within the cavity drainage system (behind and underneath membranes), within perimeter drainage channels and particularly within a sump chamber and around the sump pumps. The build-up of free lime within the Type C System will eventually cause a failure of the Waterproofing System.



Common causes of Free Lime

Free lime and mineral salts found in groundwater (particularly hard water areas) can enter a structure through construction joints and cracks in the building fabric. Free lime is particularly prevalent in new construction and retrofit construction as a by-product of the hydration process within concrete and particularly in unhydrated dry pack joints above concrete underpinning. As groundwater passes through the structure it picks up the free lime, it then deposits this, as it passes through the cavity drainage system to the point of discharge.

Minimising the impact of Free Lime

It is important when designing Type C, Drained Protection Systems that the issue of, and potential issue of, free lime is considered at the earliest stage. There are a number of ways to reduce the impact of free lime on Cavity Drainage Systems and these include:

- Inclusion of crystallisation systems, as a primary waterproof coating to structure
- Detailing all construction and dry pack joints
- Application of an anti-lime coating
- Maintainability of Type C System and ongoing maintenance
- Inclusion of a Sump Pump Notification System

Crystallisation Systems

In depth crystalline active slurry systems or concrete admixtures aid reduction of free lime and its potential impact in Cavity Drainage Systems by reacting with the free lime in new concrete and masonry to form insoluble crystalline growths as part of the waterproofing process. The impact of using such systems is two-fold, primary resistance to the passage of water through the structure and reducing the levels of free lime available to impact on the Cavity Drainage System.

Application of Anti Lime Coating

Anti-lime coatings such as Koster Polysil TG 500 should be applied over all new and existing structures prior to the installation of a Type C, Cavity Drained System. A Type C, Cavity Drained System cannot stop water picking up free lime as it passes through the structure, but it significantly reduces the amount of free lime picked up from the internal surfaces of the structure and reduces the amount of free lime impacting on the Type C System. Application of anti-lime coatings can reduce the frequency of future maintenance requirements.



TYPE C, CAVITY DRAINAGE MEMBRANES

Delta MS 20

Description

Delta MS 20 is an 20mm studded Type C, Cavity Drainage Membrane that is suitable for use on internal faces, floors or where a higher drainage capacity is required.

This High-Density Polyethylene (HDPE) cavity drainage membrane has an 20mm studded brown profile creating a large 10 litre per square meter void, ideal for high levels of water management. With its higher drainage capacity and compressive strength, this waterproof and vapour proof membrane can be used as part of a Type C waterproofing solution in accordance with BS 8102:2022 for the protection of below ground structures against the potentially adverse effects of ground water ingress.

Delta MS 20 provides an effective barrier to the transmission of salts and other contaminants.

Delta MS 20 is also suitable for tunnels, civil construction and for large commercial projects.

Please follow manufacturer's instructions for installation.

Features

- 20mm studded profile suitable for higher volumes of water penetration
- Compressive Strength: >150 kN/m²
- Drainage capacity: 10 L/s m²
- BBA Approved
- BS 8102:2022 Type C Waterproofing Protection
- Suitable for Waterproofing and damp proofing
- Suitable for flood resilience (PFR)
- Resistant to chemicals, root penetration, rotproof

Specification

- BS 8102:2022 Protection of below ground structures against water ingress. Code of practice.
- J40/290 High-density polyethylene/polypropylene studded cavity drain membrane
- J40/47 High-density polyethylene/polypropylene studded cavity drain membrane
- Classification Pr_25_57_51_74

Product details

DMS 009

Associated products

Delta Cornerstrip
Delta Sealing Rope
Delta Perimeter Drainage Channel
Delta Basement Drainage Systems
Delta MS 500

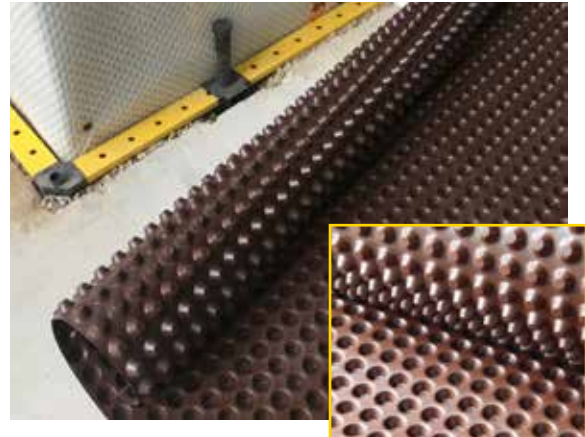

Technical data

Material	High Density Polyethylene (HDPE)
Sheet Thickness	1mm
Stud Height	20mm
Roll Size	2m x 20m
Compressive Strength	150 kN/M ²
Drainage Capacity	10 L/s m 600 L/min m 36 100 L/h m
Air volume between studs	14 L/m ²
Temperature Resistance	-30°C to +80°C
Reaction to Fire	EN13501-1 Class E
R Value	0.18 M ² K/W

'R' Value Delta MS 20

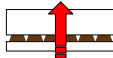
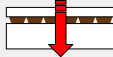
Direction of Heat Stream	TR of 20mm air gap
Horizontal 	0.18 m ² K/W
Upwards 	0.16 m ² K/W
Downwards 	0.18 m ² K/W

The thermal resistance values are calculated following DIN EN ISO 6946

Delta MS 500

Description

Delta MS 500 is an 8mm studded Type C, Cavity Drainage Membrane that is suitable for use on internal faces of walls, floors and vaulted ceilings as a water management system for the protection of below ground structures against the potentially adverse effects of ground water ingress.

This High-Density Polyethylene (HDPE) cavity drainage membrane has an 8mm studded clear profile creating a 2.25 litre per square meter void suitable for use as part of a Type C waterproofing solution in accordance with BS 8102:2022 for the protection of below ground structures against the potentially adverse effects of ground water ingress, in waterproofing structures below ground level (basements) and isolating damp walls above ground level. The stud depth of 8mm provides a suitable air gap for use as a wall applied membrane.

Delta MS 500 provides an effective barrier to the transmission of salts and other contaminants.

Please follow manufacturer's instructions for installation.

Features

- 8mm clear studded profile
- Compressive Strength: >250 kN/m²
- Drainage capacity: 2.25 l/s m²
- BBA Approved
- BS 8102:2022 Type C Waterproofing Protection
- Suitable for Waterproofing and damp proofing
- Suitable for flood resilience (PFR)
- Resistant to chemicals, root penetration, rotproof

Specification

- BS 8102:2022 Protection of below ground structures against water ingress. Code of practice.
- J40/290 High-density polyethylene/polypropylene studded cavity drain membrane
- J40/47 High-density polyethylene/polypropylene studded cavity drain membrane
- Classification Pr_25_57_51_74

Product details

DMS 005 2m x 20m

DMS 007 2.4m x 20m

Associated products

Delta Cornerstrip
Delta Qwikseal Plugs
Delta Plugs
Delta Sealing Tape
Delta MS 20



Technical data

Material	High Density Polyethylene (HDPE)
Sheet Thickness	0.5mm
Stud Height	8mm
Roll Size	2m x 20m 2.4m x 20m
Compressive Strength	>250 kN/M ²
Drainage Capacity	2.25 l/s m 135 l/min m 8 100 l/h m
Air volume between studs	5 l/m ²
Temperature Resistance	-30°C to +80°C
Reaction to Fire	EN13501-1 Class E
R Value	0.12 M ² K/W
Chemical Properties	Resistant to chemicals, root penetration, rotproof, neutral towards drinking water

'R' Value Delta MS 500

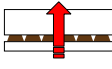
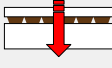
Direction of Heat Stream	TR of 8mm air gap
Horizontal 	0.12 m ² K/W
Upwards 	0.10 m ² K/W
Downwards 	0.12 m ² K/W

The thermal resistance values are calculated following DIN EN ISO 6946



TYPE C, CAVITY DRAINAGE MEMBRANES

Delta MS 500 Fire Retardant

Description

Delta MS 500 Fire Retardant is an 8mm studded cavity drain membrane with a Euroclass fire rating of B-S2, d0 (EN 13501- 1:2018) suitable for use on internal faces of walls, floors and vaulted ceilings as a water management system for the protection of below ground structures against the potentially adverse effects of ground water ingress.

This High-Density Polyethylene (HDPE) cavity drainage membrane has an 8mm studded white profile creating a large 2.25 litre per square meter void suitable for use as part of a Type C waterproofing solution in accordance with BS 8102:2022 for the protection of below ground structures against the potentially adverse effects of ground water ingress, in waterproofing structures below ground level (basements) and isolating damp walls above ground level. The stud depth of 8mm provides a suitable air gap for use as a wall applied membrane.

Delta MS 500 Fire Retardant provides an effective barrier to the transmission of salts and other contaminants.

Please follow manufacturer's instructions for installation.

Features

- 8mm studded profile
- Compressive Strength: >250 kN/m²
- Drainage capacity: 2.25 l/s m²
- BBA Approved
- Euroclass fire rating of B-S2, d0 (EN 13501- 1:2018)
- BS 8102:2022 Type C Waterproofing Protection
- Suitable for Waterproofing, damp proofing and flood resilience (PFR)
- Resistant to chemicals, root penetration, rotproof

Specification

- BS 8102:2022 Protection of below ground structures against water ingress. Code of practice.
- J40/290 High-density polyethylene/polypropylene studded cavity drain membrane
- J40/47 High-density polyethylene/polypropylene studded cavity drain membrane
- Classification Pr_25_57_51_74

Product details

DMS 850



Associated products

Delta Fire Retardant Fleece Tape
Delta Ultra Fix Plugs
Delta Sealing Tape
Delta Basement Drainage Systems
Delta MS 20
Delta Sealing Rope



Technical data

Material	High Density Polyethylene (HDPE)
Sheet Thickness	0.5mm
Stud Height	8mm
Roll Size	2.4m x 20m
Compressive Strength	>250 kN/M ²
Drainage Capacity	2.25 l/s m 135 l/min m 8 100 l/h m
Air volume between studs	5.4 l/m ²
Temperature Resistance	-30°C to +80°C
Reaction to Fire	B-S2, d0
R Value	0.12 M ² K/W

Delta AT 800

Description

Delta AT 800 is an innovative Type C Drainage Membrane which conforms to BS 8102:2022 and BS 8485:2015+A1:2019, Table 7 achieving waterproofing and ground gas protection simultaneously.

Delta AT 800 offers maximum protection in just one application. Designed to offer drainage protection in Type C waterproofing in accordance with BS 8102:2022 this innovative membrane also offers barrier protection to ground gases Carbon Dioxide, Radon and Methane in accordance with BS 8485:2015+A1:2019, Table 7 with high adhesion to the application of flame retardants.

This Virgin Polymer profiled membrane has an 9mm studded brown profile creating a large 7.9 litre per square meter void suitable for use as part of a Type C waterproofing solution in accordance with BS 8102:2022 for the protection of below ground structures against the potentially adverse effects of ground water ingress, in waterproofing structures below ground level (basements) and isolating damp walls above ground level.

Please follow manufacturer's instructions for installation.

Features

- 9mm studded profile
- Air volume between studs: 7.9 L/s m²
- An effective barrier to gas – including Methane, CO₂ and Radon
- Table 7, BS 8485:2015 +A1:2019 Code of practice for the design of protective measures for methane and carbon dioxide ground gases for new buildings
- BS 8102:2022 Type C Waterproofing Protection
- Suitable for Waterproofing, damp proofing and flood resilience (PFR)
- Resistant to chemicals, root penetration, rotproof

Specification

- BS 8102:2022 Protection of below ground structures against water ingress. Code of practice.
- BS 8485:2015+A1: 2019 Code of practice for the design of protective measures for methane and carbon dioxide ground gases for new buildings
- J40/290 High-density polyethylene/polypropylene studded cavity drain membrane
- J40/47 High-density polyethylene/polypropylene studded cavity drain membrane
- Classification Pr_25_57_51_74

Product details

DMS 026

Associated products

Delta Qwikseal Plugs
Delta Sealing Tape
Delta Cornerstrip
Delta Gas Over Tape 150
Delta LM 800



Technical data

Material	Highly stabilized Virgin HPDE
Stud Height	9mm
Flat edge/self adhesive edge	Yes/none
Roll Size	2m x 20m
Air volume Between Studs	7.9 L/m ²
Contact area dimples/surface	700 cm ² /m ²
Diagonal Dimples per m ²	2500 pcs
Temperature Resistance	-30°C to +80°C
Reaction to Fire	EN 13501-1 Class E
Straightness	Passed <75 mm/10m

TYPE C, CAVITY DRAINAGE MEMBRANES

Delta PT 3mm

Delta PT 3mm mesh membrane has been developed specifically for addressing the issues of damp and contaminated walls, or where fast reinstatement of wall finishes is required after chemical damp proof injection.

Delta PT 3mm a High-Density Polyethylene (HDPE) low profile studded membrane with a heat welded polypropylene mesh provides a key for plaster, renders or dab fix of plaster boards.

Delta PT 3mm is impervious to moisture and moisture vapour creating a new barrier between old surfaces and new internal finishes. Delta PT 3mm effectively isolates damp walls and will prevent any new salts to deposit on surface plasters and decoration.

Please follow manufacturer's instructions for installation.

Features

- 3mm studded profile
- Drainage capacity 2 l/s m²
- Air Volume between studs 2 l/s m²
- An effective barrier to the transmission of salts, liquid water and water vapour
- Provides key for plaster, renders or dab fix
- Resistant to chemicals, root penetration, rotproof and neutral towards drinking water

Specification

- BS 8102:2022 Protection of below ground structures against water ingress. Code of practice.
- J40/290 High-density polyethylene/polypropylene studded cavity drain membrane
- J40/47 High-density polyethylene/polypropylene studded cavity drain membrane
- Classification Pr_25_57_51_74

Product details

DMS 030 1m x 20m
DMS 027 2m x 20m

Associated products

Delta Qwikseal Plugs
Delta PT Plugs
Delta Ultra Fix Plugs
Delta Sealing Tape
Delta Cornerstrip
Delta LM 800



Technical data

Material	High Density Polyethylene (HDPE)
Sheet Thickness	0.4mm
Stud Height	3mm
Roll Size	1m x 20m 2m x 20m
Air volume between studs	2 l/m ²
Temperature Resistance	-30°C to +80°C
Reaction to Fire	EN13501-1 Class E
R Value	Theoretical value based on a supposed specific thermal conductivity of HPDE 0.42 W/m x K, the R value would be 0.001
Vapour resistivity:	
Sd-value	236.4 m
Thickness	0.000921 m
U-value	256.678
Vapour resistivity	1283.388 MNs/gm



Delta PT

Delta PT is an 8mm studded Type C, Cavity Drainage Membrane that is suitable for use in basement waterproofing for new and existing structures. Delta PT can also be used in above ground application to provide a damp proof barrier and to isolate plaster finishes from contamination.

Delta PT is a High-Density Polyethylene (HDPE) 8mm studded membrane with a heat welded polypropylene mesh. Delta PT is suitable as an impermeable damp proofing base for plaster or shotcrete (with suitable reinforcement) and as a water control and drainage membrane in tunnel construction or for remedial damp proofing and waterproofing of existing basements internally.

Please follow manufacturer's instructions for installation.

Features

- 8mm studded profile
- Compressive Strength: 70 kN/m²
- Drainage capacity: 5 l/s m²
- An effective barrier to the transmission of salts, liquid water and water vapour
- A "reversible" system, which will minimise damage to historical or heritage structures
- Resistant to chemicals, root penetration, rotproof, neutral towards drinking water

Specification

- BS 8102:2022 Protection of below ground structures against water ingress. Code of practice.
- J40/290 High-density polyethylene/polypropylene studded cavity drain membrane
- J40/47 High-density polyethylene/polypropylene studded cavity drain membrane
- Classification Pr_25_57_51_74

Product details

DMS 001 1.5m x 10m
DMS 002 2m x 20m

Associated products

Delta PT Plugs
Delta Flexi Dri Plus Plugs
Delta Ultra Fix Plugs
Delta Cornerstrip
Delta Sealing Tape
PT Profile Strip



Technical data

Material	High Density Polyethylene (HDPE)
Sheet Thickness	0.5mm
Stud Height	8mm/7mm
Roll Size	1.5m x 10m 2m x 20m
Compressive Strength	70 kN/M ²
Drainage Capacity	5 l/m ² 300 l/min m 18 100 l/h m
Air volume between studs	5.5 l/m ²
Temperature Resistance	-30°C to +80°C
Reaction to Fire	EN13501-1 Class E

'R' Value Delta PT

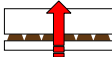
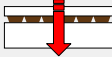
Direction of Heat Stream	TR of 8mm air gap
Horizontal 	0.12 m ² K/W
Upwards 	0.10 m ² K/W
Downwards 	0.12 m ² K/W

The thermal resistance values are calculated following DIN EN ISO 6946



TYPE C, CAVITY DRAINAGE MEMBRANES

Delta FM

Delta FM is a Virgin High Performance PE-VHD membrane specifically designed for floor applications to combat capillary dampness and contamination.

This membrane Virgin High Performance PE-VHD membrane has an 4mm studded brown profile to minimise the impact upon existing floor levels but still provides an air gap to achieve damp pressure equalisation. The special low profile offered by Delta FM is excellent for detailing existing staircases and tight spaces. Delta FM can be linked to other Delta cavity drainage membranes.

A fast-track application which allows for various floor finishes to be achieved with zero 'down time'.

Please follow manufacturer's instructions for installation.

Features

- 4mm studded profile
- Compressive Strength: >700 kN/m²
- Air volume between studs: 2 l/s m²
- BBA Approved
- Protection for high quality floor finishes e.g. hardwood and screeds
- Creates a continuous air gap to achieve damp pressure equalisation
- Fast track application achieved with zero "down time"

Specification

- BS 8102:2022 Protection of below ground structures against water ingress. Code of practice.
- J40/290 High-density polyethylene/polypropylene studded cavity drain membrane
- J40/47 High-density polyethylene/polypropylene studded cavity drain membrane
- Classification Pr_25_57_51_74

Product details

DMS 023

Associated products

Delta Cornerstrip
Delta Sealing Tape
Delta Perimeter Drainage Channel
Delta Basement Drainage Systems
Delta MS 500



Technical data

Material	Virgin high-performance PE-VHD
Application	Special low stud profile for floor. Can be used on walls.
Sheet Thickness	0.6mm
Stud Height	4mm
Roll Size	2 x 2m (40m ²)
Compressive Strength	700 KN/M ²
Air volume between studs	2.6 l/m ²
Temperature Resistance	-30°C to +80°C
Reaction to Fire	EN13501-1 Class E

'R' Value Delta FM

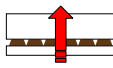
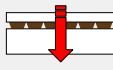
Direction of Heat Stream	TR of 20mm air gap
Horizontal 	0.06 m ² K/W
Upwards 	0.04 m ² K/W
Downwards 	0.06 m ² K/W

The thermal resistance values are calculated following DIN EN ISO 6946



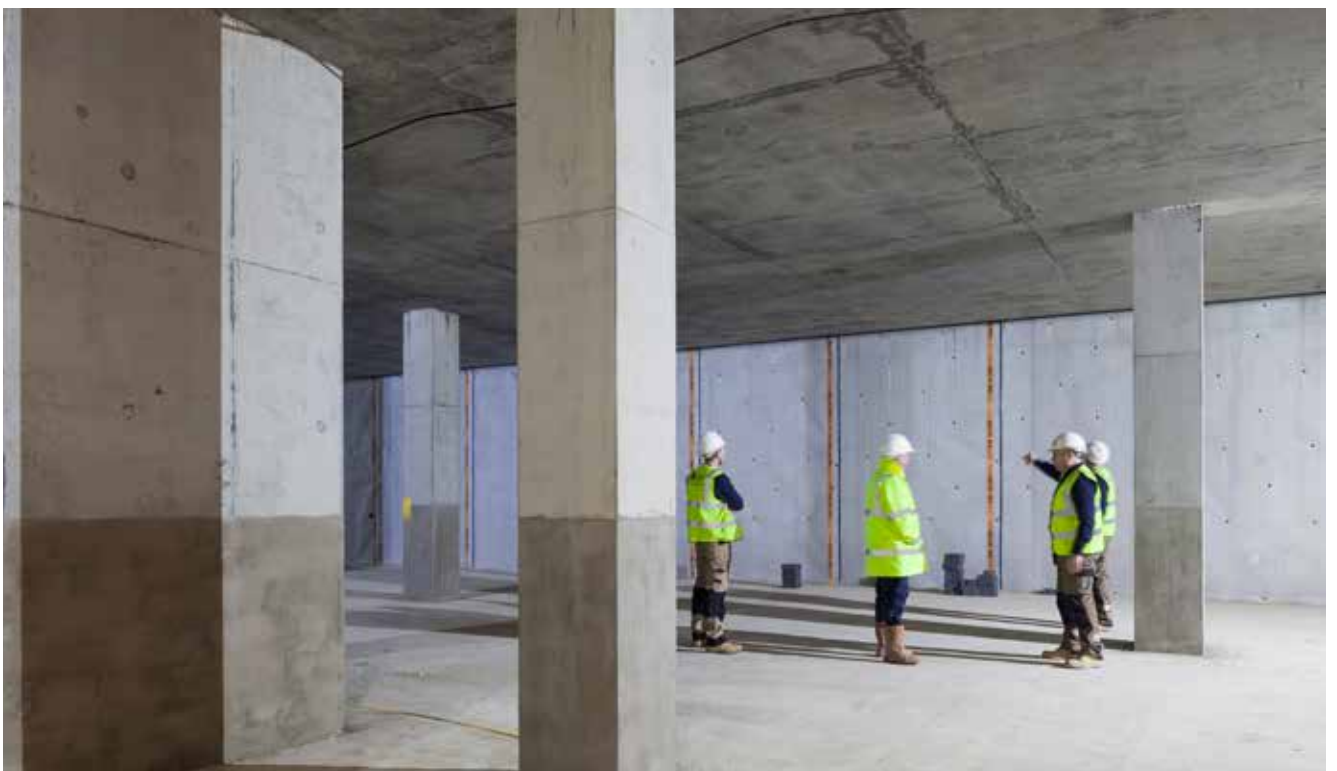

TYPE C, CAVITY DRAINAGE MEMBRANES

Type C Ancillaries

	Sealing Rope DMS 011 4.75m x 10mm
	Corner Strip DMS 020 150mm x 20m
	Double Sided Tape DMS 012 22.5m x 28mm
	Fire Retardant Fleece Tape DMS 852 1mm x 220mm x 20m
	Fleece Tape DMS 238 100mm x 20m
	Delta Plugs DMS 014 Box of 100
	Flexi-Dri Plus Plugs DMS 239 Box of 100
	Qwikseal Plugs DMS 131 Box of 100
	Ultra Fix Plugs DMS 051 Box of 200 DMS 050 Box of 200 with Grommets
	PT Plugs DMS 015-1 Box of 200 DMS 133-1 Box of 200 with Grommets
	Delta Than DMS 019 310ml

	Delta Mastic DMS 013 400ml
	Delta Fix Adhesive DMS 018 400ml (Fix Adhesive) DMS 044 Fix Mixer Nozzles DMS 043 Twin Cartridge Applicator
	Puddle Flange DMS 161 Various sizes available from 32mm to 160mm
	PT Profile Strip DMS 016 2m length
	MS Profile Strip DMS 017 2m length
	GL2 Brackets DMS 049 Box of 100
	Joist Boots / Top Hats Special order Made to order
	Water Based Epoxy Resin DMS 485 2.5ltr White DMS 486 2.5ltr Clear DMS 487 2.5ltr Grey DMS 488 2.5ltr Blue DMS 144 5ltr White DMS 148 5ltr Clear DMS 149 5ltr Grey DMS 150 5ltr Blue
	Water Based Epoxy Resin DMS 300 100mm x 20m DMS 301 150mm x 20m DMS 303 300mm x 20m DMS 304 450mm x 20m DMS 305 600mm x 20m DMS 345 1000mm x 20m

Coverage Table

Membrane	Measurement	Working m ²	Fixings *Estimated	Application
Delta MS 500 8mm	2m x 20m	38.6m ²	<ul style="list-style-type: none"> • Qwikseal *(5 plugs per m²) • Delta Plugs sealed with rope *(5 plugs per m²) 	Waterproofing
Delta MS 500 Large 8mm	2.4m x 20m	46m ²	<ul style="list-style-type: none"> • Qwikseal *(5 plugs per m²) • Delta Plugs sealed with rope *(5 plugs per m²) 	Waterproofing
Delta MS 500 Fire Retardant	2.4m x 20m	46m ²	<ul style="list-style-type: none"> • Ultra Fix *(5 plugs per m²) sealed with rope 	Waterproofing
Delta PT 8mm	2m x 20m	36m ²	<ul style="list-style-type: none"> • PT Plugs sealed with rope *(18 plugs per m²) • PT Plugs with Grommets *(18 plugs per m²) 	Waterproofing
Delta PT 3mm	2m x 20m	38.6m ²	<ul style="list-style-type: none"> • PT Plugs sealed with rope *(18 plugs per m²) • PT Plugs with Grommets *(18 plugs per m²) 	Damp Proofing
Delta PT 3mm	1m x 20m	19m ²	<ul style="list-style-type: none"> • PT Plugs sealed with rope *(18 plugs per m²) • PT Plugs with Grommets *(18 plugs per m²) 	Damp Proofing
Delta Lath Clear 8mm	1.5m x 10m	14m ²	<ul style="list-style-type: none"> • PT Plugs sealed with rope *(18 plugs per m²) • PT Plugs with Grommets *(18 plugs per m²) 	Damp Proofing
Delta MS 20 20mm	2m x 20m	38m ²	N/A	Waterproofing
Delta FM 4mm	2m x 20m	38.6m ²	N/A	Damp Proofing
AT800 9mm	2m x 20m	38.6m ²	<ul style="list-style-type: none"> • Delta Plugs *** (5 plugs per m²) sealed with rope • Qwikseal Plugs with PU 907 to seal inside screw hole *** (5 plugs per m²) • Fire Retardant Ultra Fix Plugs *(5 plugs per m²) sealed with rope 	Waterproofing

Fixings

Membrane	Plugs*	Rope (10mm x 4.75m)	Delta Tape (28mm x 22.5m)	Corner Strip (150mm x 20m)	Fleece Tape (100mm x 20m)	Fire Retardant Fleece Tape (220mm x 20m)
For Stud to Stud application	For sealing membranes together at overlaps and adjacent seals	For sealing wall to floor junctions, service penetrations and patch repairs	For PT Membranes ideal for plastering and rendering onto.	For sealing of membranes together, join or where overlapping is required and butt joints.		
Delta MS 500 8mm	✓	✓	✓	✓		
Delta MS 500 Large 8mm	✓	✓	✓	✓		
Delta MS 500 Fire Retardant	✓	✓	✓			✓
Delta PT 8mm	✓	✓	✓		✓	
Delta PT 3mm	✓	✓			✓	
Delta Lath Clear 8mm	✓				✓	
Delta MS 20 20mm		✓		✓		
Delta FM 4mm		✓	✓	✓		
AT800 9mm	✓	✓	✓	✓		

BASEMENT DRAINAGE

Drainage Design

When waterproofing a below ground structure with a Type C cavity drainage membrane system, a basement drainage system is also required to safely remove ground water ingress which percolates the structure.

This drainage system is made up of four key components - a submersible pump, often referred to as a sump pump, basement drainage channels, high level water alarm(s) and battery backup(s), larger projects may also require a control panel.

The first stage of a cavity drainage system install is to provide an accessible and maintainable drainage system. Whether new build or retrofitting, the drainage system is always the first step.

Drainage can be use of perimeter drainage channel or a modular drainage system.

Modular drainage systems are only possible where the construction is new or there is a new structural slab being cast.

Perimeter drainage channel can be used for new construction and retrofitting projects. Recesses for the perimeter drainage channel are created in the structural slab. Contrary to new build scenarios, when retrofitting there may be limitations to alterations to the existing slab, to overcome this problem a 50mm sacrificial screed detail can be used to create the required rebates.

With multi-level basements, we take a slightly different approach. Generally, with a new build multi-level basement, we tie the intermediate slab into the membrane for continuity of the waterproofing system. [Technical drawing 218-1(C)], as with all waterproofing projects, this is not always possible. Where not possible we use an alternative approach, such as the 126 Detail [Technical drawing 216-1-(c)].

Both perimeter drainage channels and modular drainage will efficiently disperse any water ingress which percolates the structure to a sump chamber. Once water is collected into the sump chamber, the water is then safe evacuated to a suitable discharge point. This is referred to as a sump pump system.

The sump chamber will collect and manage any water ingress which is collected in the cavity drain membranes via drainage system.

High-water level alarm, control panels and battery backups are a second line of defence for the basement drainage system, a high-level water alarm will notify building occupants if the sump pump system has stopped working or are working at different parameters, whilst battery backups will maintain a power supply to the sump pumps in the event of a power outage.

Sump pump systems protect a property against flooding.

As with any electrical equipment, basement sump pumps will require servicing and the entire drainage system will require regular maintenance to ensure it is working effectively.

If you already have a cavity drainage waterproofing/ Type C system, installed, it is vitally important to maintain all equipment annually (as a minimum). If you are planning on having a cavity drainage waterproofing system installed in your property, always remember the system should be fully maintainable and regularly serviced.

Think of sump pumps as the beating heart of your basement, removing water ingress that could result in a flooded basement.



Routine Maintenance Benefits:

- Reliable and cost-effective maintenance tailored to suit your property
- Reduced risk of breakdown leading to a flooded basement
- Increased life expectancy of equipment
- Fully trained engineers
- Ensures efficient operation of waterproofing system and minimises downtime
- All staff are confined space trained

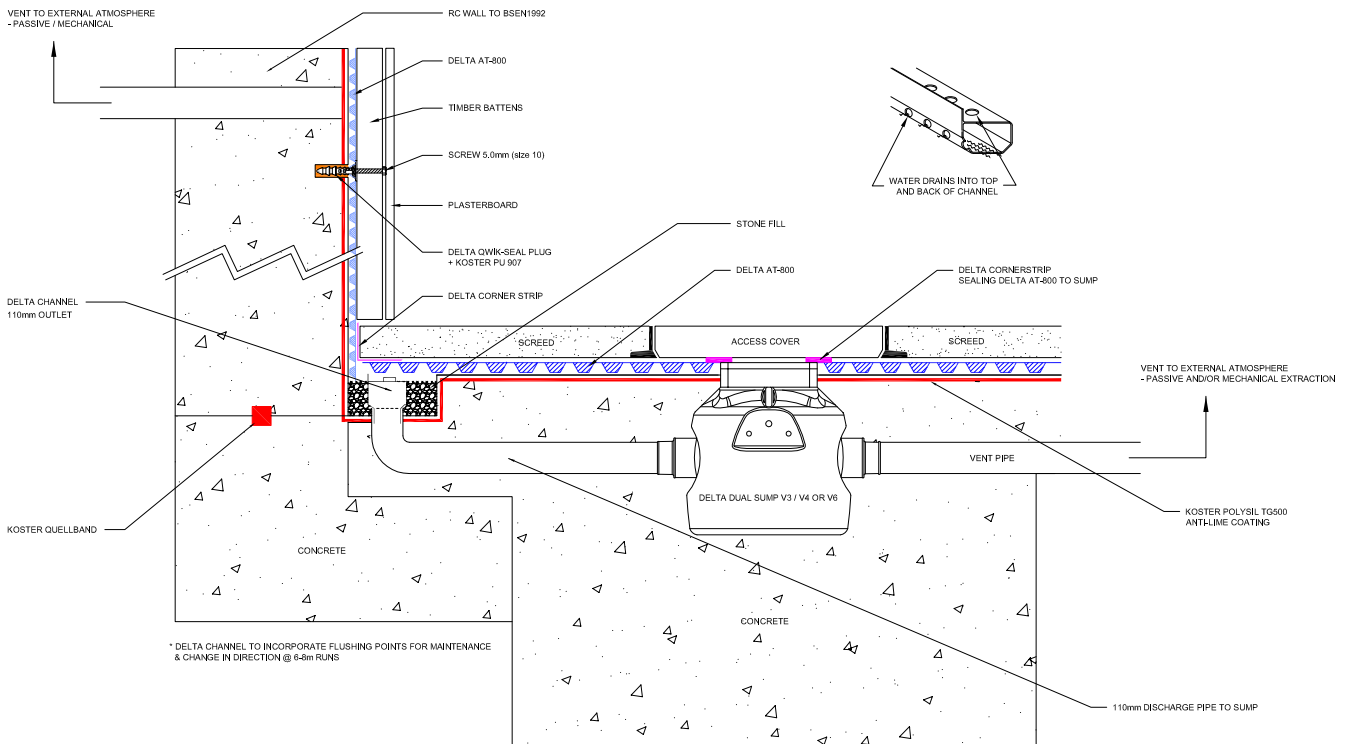

The purpose of a sump chamber is to collect and discharge (to a suitable evacuation point) any water ingress which has collected behind the cavity drain membrane system.

Basement drainage 'pumped systems' should be engineered to cope with worst-case scenario of water ingress. It should always be assumed that ground water is expected to rise against any structure at some point during its service life. Waterproofing designs should always be to the full height of the external ground level with consideration to the connection with the dpc 150mm above ground level. This may be within the cavity or dressed externally with a flashing.

Drainage channels ideally should be installed in rebates and laid level at the wall/floor junction around the perimeter of the structure to allow water to drain by hydraulic gradient and to discharge passively into sump chambers. For larger projects, cross-floor span channels should be included in designs.

Inspection and access ports should be included in the perimeter drainage channel design. These allow for inspection, maintenance, and future cleaning of the drainage system.

The number of sump pump systems required for each project will (in part) depend on the overall basement size, perimeter, and the method of drainage. Type C membranes should be installed above drainage channels.

For each sump system, we recommend two pumps to reduce risk in case of mechanical failure of the duty pump. In the event of failure of the duty pump, the secondary back up pump will take over discharging water ingress, ensuring the basement drainage is functional, significantly reducing the risk of potential flooding.

Basement drainage systems are further enhanced with additional protection with high-water level alarm, control panels and battery backups as a second line of defence. A high-level water alarm will notify a building owner/ occupier if the sump pump system has stopped working. Battery backups will maintain power supply to sump pumps in the event of a power outage.

Multi-level systems should be detailed to allow water ingress to bypass any intermediate suspended floor slab(s) to reach drainage installed at the lowest level of the structure. For multi-level systems we recommend the additional use of a Type A or Type B waterproofer to offer a continuous waterproofing approach.

Design considerations should be given to the serviceability and maintainability of the system, such as maintainable perimeter drainage and servicing of sump pumps.

BASEMENT DRAINAGE

Perimeter Drainage Channel

Perimeter Drainage Channel is a component part used within a Type C Cavity Drainage System for collection and control of water which ingresses. Delta Channel is a distinctive yellow, PVC drainage conduit designed to manage water ingress and hydrostatic water pressure in basements and below ground structures.

Delta Channel is bedded into a preformed rebate (recess/gully) at the floor/wall junction and is suited for use in conjunction with the Delta Membrane range. Preformed holes within the Delta Channel allow for water to enter, then drain into a suitable package pump station or suitable discharge point. Access points within the Delta Channel should be installed to allow for maintenance and inspection.

When using drainage channels these should be set directly below the level of the floor cavity membrane, so that the full drainage capacity of the system is available.

We recommend one Packaged Pump System should be installed for each 50 linear metres of channel; the length of each channel running to the Sump should not exceed 25m.

Delta Channel is supplied in 2 metre lengths and is available with or without an upstand. Delta Channel is 80 mm wide and 50 mm deep.

The Delta Channel is joined by a range of accessories such as Straight Connectors, Corner Pieces, T Pieces and Drainage Channel End Caps. Where it is not possible to recess the channel into the structural slab we recommend speaking to Delta's Technical Team.

A modular drainage system may also be adopted or combined with a Delta Channel System.

We recognise that every project has different requirements and therefore our Technical Team work together as one, to provide tailored solutions that meet specific needs. We manufacture all our packaged pump stations in-house from design, through to assembly and testing. Our Technical Team will help from specification to installation and maintenance.



We recognise that every project has different requirements and therefore our Technical Team work together as one, to provide tailored solutions that meet specific needs.

Drainage Configuration

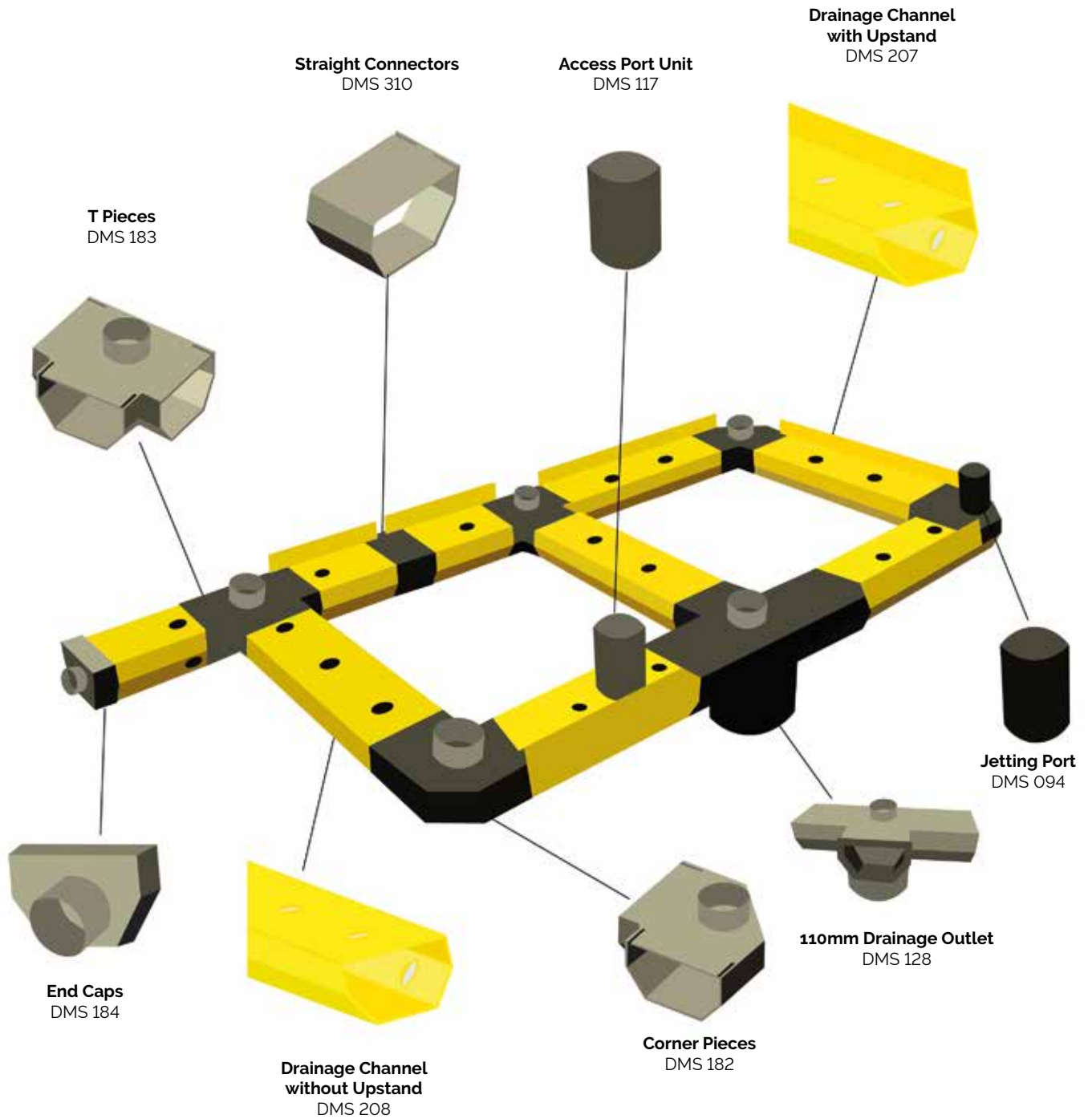

Drainage Channel and Accessories



Delta Channel with Upstand
DMS 207 2m length



Delta Channel without Upstand
DMS 208 2m length



Straight Connectors
DMS 310



Corner Pieces
DMS 182



T Pieces
DMS 183



End Caps
DMS 184



110mm Drainage Outlet
DMS 128



MS 20 Flushing / Access Port
DMS 124



Inspection Port (Jetting Eye)
DMS 094



Access Port Unit
DMS 117



Drainage Connector
DMS 118



Pressure pipe, PVC Class E, 2m
1¼" 2" 2½" 3"
E100 E120 E140 E150



Tank connector
1¼" 2" 2½" 3"
E110 E130 E145 E155



90° elbow PL/PL
1¼" 2" 2½" 3"
E101 E121 E141 E151



45° elbow PL/PL
1¼" 2" 2½" 3"
E102 E122 E142 E152



Tee-piece PL/PL
1¼" 2" 2½" 3"
E105 E125 - -



Coupling (socket) PL/PL
1¼" 2" 2½" 3"
E103 E123 E143 E153



Socket union PL/PL
1¼" 2" 2½" 3"
E106 E126 - -



Male threaded adaptor
1¼" 2" 2½" 3"
E104 E124 E144 E154



Coupling PL/TH
1¼" 2" 2½" 3"
E107 E127 - -



Barrel nipple PL/TH
1¼" 2" 2½" 3"
E108 E128 - -



Barrel nipple TH/TH
1¼" 2" 2½" 3"
E109 E129 - -

	Coupling TH/TH			
	1¼"	2"	2½"	3"
	E111	E133	-	-
	Delta 2" to 1¼" Reducer Kit			
	2" to 1¼"			
	E219			
	Reducing socket, PL/PL			
	2" to 1½"			
	E160			
	Reducing bush, PL/TH			
	1½" to 1¼"			
	E161			
	Male iron, low pressure			
	1¼"/32 mm	2"/50 mm		
	E112	E132		
	Backnut, ABS c/w rubber washer			
	2" BSP			
	E134			
	O-ring for socket union			
	1¼"	2"		
	E114	E115		
	110mm saddle clamp, reinforced			
	1¼"	2"	2½"	3"
	E113	E133	E146	E156
	Rubber drain coupling			
	50-65mm			
	E174			
	Rubber wall seal			
	50mm	110mm	160mm	
	E168	E169	E170	
	Brass gate valve			
	1¼"	2"		
	E187	E188		

	Brass swing check valve			
	1¼"	2"	2½"	3"
	E191	E193	-	-
	Delta V3/4/6 non-return valve			
	1¼"			
	E195			
	PP, industrial pipe clip, black			
	1¼"	2"		
	E114	E115		
	Solvent cement, WDF-05			
	250 ml			
	E175			
	PVC cleaning fluid			
	500 ml			
	E176			
	PTFE tape, roll			
	12mm x 12m			
	E177			

SUBMERSIBLE PUMPS

Delta V3 Submersible Pump

Description

The Delta V3 Submersible Pump has been specifically designed for below ground application.

Offering elite performance, the Delta V3 achieves high levels of efficiency thanks to its optimised hydraulic systems and reliable motors.

Fitted with a magnetic float switch the Delta V3 provides variable level control and maximum travel stop.

The powerful vortex pump offers innovative design and advanced technology making it extremely reliable even when subjected to continuous use (subject to correct installation).

A straightforward locking disk enables adaption of the pump to external control systems.

The Delta V3 Submersible Pump is suitable for collecting ground water from a Cavity Drained System.



V3

V4/V6

Features

- Suitable for ground, surface, storm, and grey water applications
- Maximum flow rate up to 2.9 l/s
- 1.25" BSP threaded pump outlet
- Superior vortex hydraulics for blockage free pumping
- Internal thermal protection
- Designed for easy installation
- Available with float locking disc for manual level control

Product details

DMS 116-1



Delta V4 Submersible Pump

Description

The Delta V4 Submersible Pump is light-weight and corrosion-proof due to its high-quality plastic casing. Thanks to its noise-absorbing, abrasion proof and impact-resistant features, the Delta V4 is a popular choice with waterproofing professionals.

The Delta V4 is suitable for double depth basements with a head height of 8 m.

The powerful Vortex pump offers innovative design and advanced technology making it extremely reliable even when subjected to continuous use (subject to correct installation).

The Delta V4 is supplied free standing for quick installation.

Features

- Suitable for ground, surface, storm, and grey water applications
- Maximum flow rate up to 3.3 l/s
- 1.25" BSP threaded pump outlet
- Superior vortex hydraulics for blockage free pumping in critical conditions
- Internal thermal protection
- Designed for easy installation
- Available with float locking disc for manual level control

Product details

DMS 216-1



Delta V6 Submersible Pump

Description

The Delta V6 Submersible Pump is a reliable heavy-duty pump. The Delta V6 is suitable for double and triple depth basements with a head height up to 12 m.

The Delta V6 Submersible Pump is suitable to collect ground water from a 150 m² basement and surface water from 12 m² of light well area. The Delta V6 Submersible Pump is suitable for pumping of surface water.

The powerful vortex pump offers innovative design and advanced technology making it extremely reliable even when subjected to continuous use (subject to correct installation).

The Delta V6 is supplied free standing for quick installation.

Features

- Suitable for ground, surface, storm, and grey water applications
- Maximum flow rate up to 3.9 l/s
- 1.25" BSP threaded pump outlet
- Superior vortex hydraulics for blockage free pumping in critical conditions
- Internal thermal protection
- Designed for easy installation
- Available with float locking disc for manual level control

Product details

DMS 084-1



Delta Foul V3 Submersible Pump

Description

The Delta Foul V3 Submersible Pump is designed as a compact and cost-effective solution for collection of foul and/or grey water from basements, below ground structures and ground floor extensions.

The robust and reliable Delta Foul V3 is an exceptionally popular choice with waterproofing professionals due to its generous sized motor, thermal overload protection and ease of installation.

The powerful Vortex pump offers innovative design and advanced technology making it extremely reliable even when subjected to continuous use (subject to correct installation). With a 45mm solids clearance the Delta Foul V3 offers reliable and effective discharging..

The Delta Foul V3 can be supplied free standing or on pedestal mounting for permanent installation.

The Delta Foul V3 Submersible pump is not suitable for collecting ground water from a Cavity Drained System.

Features

- Maximum flow rate up to 6.3 l/s
- Maximum head (lift height) 12m
- 2" BSP threaded pump outlet
- Includes float, elbow and outlet reducer adaptors
- Trouble free operation
- Free flowing impeller (preventing clogging)
- Corrosion resistant stainless-steel shaft and bi-rotational mechanical seal
- Designed for easy installation
- Available with pedestal mounting

Product details

DMS E029 (Manual)

DMS 120-1 (Automatic)

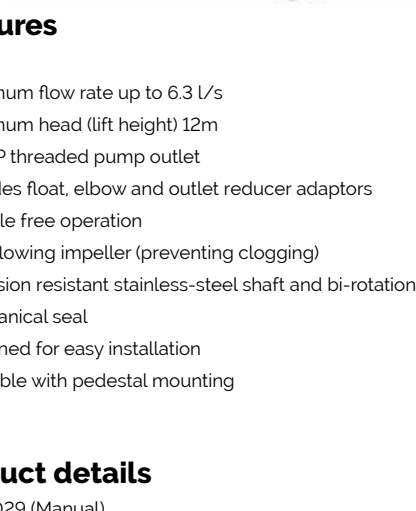

PACKAGED PUMPS

Delta Dual V3 Packaged Pumping Station

Description

The Delta Dual V3 packaged pump station has been specifically designed to work in harmony with Cavity Drained Systems to collect Ground Water via a perimeter drainage channel or modular drainage. Manufactured from superior High-Density Polyethylene (HDPE) this packaged pump station can withstand hydrostatic forces encountered in applications with high water tables. Pumping applications are invariably demanding – typically operating in unsympathetic, arduous, or extreme environments, where quality matters.

The powerful Vortex pump offers innovative design and advanced technology making it extremely dependable even when subjected to continuous use (subject to correct installation).

The Delta Dual V3 pump offers unrivalled capabilities. The Delta Dual V3 sump offers versatility of collecting water from external light wells. The Delta Dual V3 packaged pump station includes chamber, all internal pipe work and two powerful Delta V3 pumps. The Delta Dual V3 pump station is suitable for collecting ground water from a 150m² basement and surface water from a maximum 12m² light well.



Product Description

DMS 164-1



Delta Dual V4 Packaged Pumping Station

Description

The Delta Dual V4 packaged pump station has been designed specifically to work in unity with the Delta Cavity Drained System (Type C waterproofing) to collect ground water via a perimeter channel or modular drainage.

Delta's robust and distinguished package pumps are capable of diverse applications where quality matters. Using advanced pump design techniques our packaged pump systems are unrivalled.

The Delta Dual V4 offers a higher discharge head to the Delta V3 pump(s). The Delta Dual V4 pump station is suitable to collect ground water from a 150m² basement that requires a head height of up to 8 m. The Delta Dual V4 is capable of pumping 12m² of surface area in addition to ground water.

The Delta V4 pump station includes chamber, all internal pipework and two powerful Delta V4 Pumps.

The Delta Dual V4 pump station should not be used to collect grey water from showers and hand basins, or foul water from a water closet.



Product Description

DMS 217-1



Delta Dual V6 Packaged Pumping Station

Description

Manufactured to the highest of quality, the Delta Dual V6 package pump station can meet the requirements of the toughest environment. The Delta Dual V6 has the capabilities to discharge water ingress from surface areas over 150m² or basements that require a head height up to 10 m.

The Delta Dual V6 packaged pump station has been distinctively designed to work in harmony with the Delta Type C System, to collect groundwater via a perimeter drainage channel or modular drainage. Manufactured from high-density polyethylene (HDPE), this package pump station can effortlessly withstand the strongest hydrostatic stress.

The Delta Dual V6 pump station package includes chamber, all internal pipe work and two powerful Delta V6 Submersible Pumps. The system's pumps are factory-set to activate at different levels, providing both primary and secondary protection. The powerful Delta V6 Submersible Pump offers innovative design and advanced technology making it extremely reliable even when subjected to continuous use (subject to correct installation).



Product Description

DMS 079-1



Delta V3 Foul Packaged Pumping Station

Description

The Delta Foul V3 Packaged Pumping Station has been specifically designed to collect foul and/or grey water from basements, below ground structures and ground floor extensions.

Superior design, precision manufacturing and high-quality assurance has made Delta a trusted name for package pump stations. The robust and reliable Delta Foul V3 is an exceptionally popular choice with waterproofing professionals due to its generous sized motor, thermal overload protection and ease of installation. The powerful vortex pump offers innovative design and advanced technology making it extremely dependable even when subjected to continuous use (subject to correct installation).

The Delta Foul V3 chamber is manufactured from virgin tank grade HDPE and is capable of withstanding hydrostatic forces encountered in applications with high water tables.

The Delta Foul V3 includes a chamber, all internal pipework, and a powerful Delta Foul V3 Submersible Pump.



Product Description

DMS 165-2



HIGH WATER LEVEL ALARMS

High Water Level Alarm & Battery Backups

Delta HLA - Foul

Description

The Delta HLA Foul is designed to detect high water levels within a foul sump pump (submersible pump) chamber. The Delta HLA Foul is an independent high water level alarm with a clear display on the front fascia via LED, which acts as a warning system in the event of:

- power failure to the Delta HLA Foul
- a high water level situation in the chamber/sump
- a high water level situation is recorded
- a service due

Product details

DMS 191-1



Delta HLA - Groundwater

Description

The Delta HLA Groundwater is designed to detect high water levels within a groundwater/surface water sump pump (submersible pump) chamber. The Delta HLA Groundwater is an independent high water level alarm with a clear display on the front fascia via LED, which acts as a warning system in the event of:

- power failure to the Delta HLA Groundwater
- a high water level situation in the chamber/sump
- a high water level situation is recorded
- a service due

Product details

DMS 190-1



Delta HLA - 800 Series

Description

The Delta HLA 800 Series is designed to detect high water levels within a Delta 800 Series sump pump (submersible pump) chamber. The Delta HLA 800 Series is an independent high water level alarm with a clear display on the front fascia via LED, which acts as a warning system in the event of:

- power failure to the Delta HLA 800 Series
- a high water level situation in the chamber/sump
- a high water level situation is recorded
- a service due

Product details

DMS 191-1



Delta UPS V3

Description

If power failure occurs, the Delta UPS V3 automatically powers the Delta V3 pump. It can provide power for 30 minutes continuously, based on a 3.5 m head. This is equivalent to 30 hours protection, in accordance with PCA guidance of a minimum of three activations per hour.

Product details

DMS E021



Delta UPS V4/6

Description

The Delta UPS V4/6 is specifically designed for basement drainage systems (submersible pumps/sump pumps) when there is a loss of mains power. It will power one Delta V3, Delta V4, or Delta V6 Submersible Pump during a power outage, keeping basements dry.

The Delta UPS V4/6 can provide power to a Delta V6 pump for 30 minutes continuously, based on a 3.5 m head. This is equivalent to 30 hours protection, in accordance with PCA guidance of a minimum of three activations per hour.

Product details

DMS E022



Delta Battery Backup Foul V3

Description

The Delta Battery Backup Foul V3 is specifically designed to provide power to one Delta Foul V3 Packaged Pumping Station or a Delta Single Foul 800 Packaged Pumping Station when there is a loss of network power. The Delta Battery Backup Foul V3 will keep submersible pumps running during power outage(s).

The Delta Battery Backup Foul V3 will provide power for more than 3 days* (30 minutes continuously) to one Delta Foul V3 pump in case of a loss of network power. If power failure occurs, the pump automatically takes power from the Delta Battery Backup Foul V3.

Product details

DMS E030



BATTERY PACKS

Delta Battery Backups

Delta Battery Backup V3

Description

The Delta Battery Backup V3 will provide power for 60 minutes run time/5 days back up* to one Delta V3 pump in case of a loss of mains power. If power failure occurs, the pump will automatically take power from the Delta Battery Backup V3.

Simple to use and easy to install – the Delta Battery Backup V3 will clearly display status and comprehensive fault codes. *Based on PCA guidance of minimum 3 activations per hour for 24 hours.

Product details

DMS E023



Delta Battery Backup V3 Plus

Description

The Delta Battery Backup V3 Plus will provide power for 120 minutes run time/10 days back up* to one Delta V3 pump in case of a loss of mains power. If power failure occurs, the pump will automatically take power from the Delta Battery Backup V3 Plus.

Simple to use and easy to install – the Delta Battery Backup V3 Plus will clearly display status and comprehensive fault codes. *Based on PCA guidance of minimum 3 activations per hour for 24 hours.

Product details

DMS E024



Delta Battery Backup V4/6

Description

The Delta Battery Backup V4/6 will provide power for 45 hours* to one or two Delta V6 pumps (not simultaneously) in case of a loss of mains power. If power failure occurs, the pump(s) automatically take power from the Delta Battery Backup V4/6 .

Simple to use and easy to install – the Delta Battery Backup V4/6 will clearly display status and comprehensive fault codes. *Based on PCA guidance of minimum 3 activations per hour.

Product details

DMS E026



Delta Battery Backup V4/6 Plus

Description

The Delta Battery Backup V4/6 Plus will provide power for 90 minutes run time/7 days back up* to one Delta V4/V6 pump (not simultaneously) in case of a loss of mains power. If power failure occurs, the pump will automatically take power from the Delta Battery Backup V4/6 Plus.

Simple to use and easy to install – the Delta Battery Backup V4/6 Plus will clearly display status and comprehensive fault codes. *Based on PCA guidance of minimum 3 activations per hour for 24 hours.

Product details

DMS E027

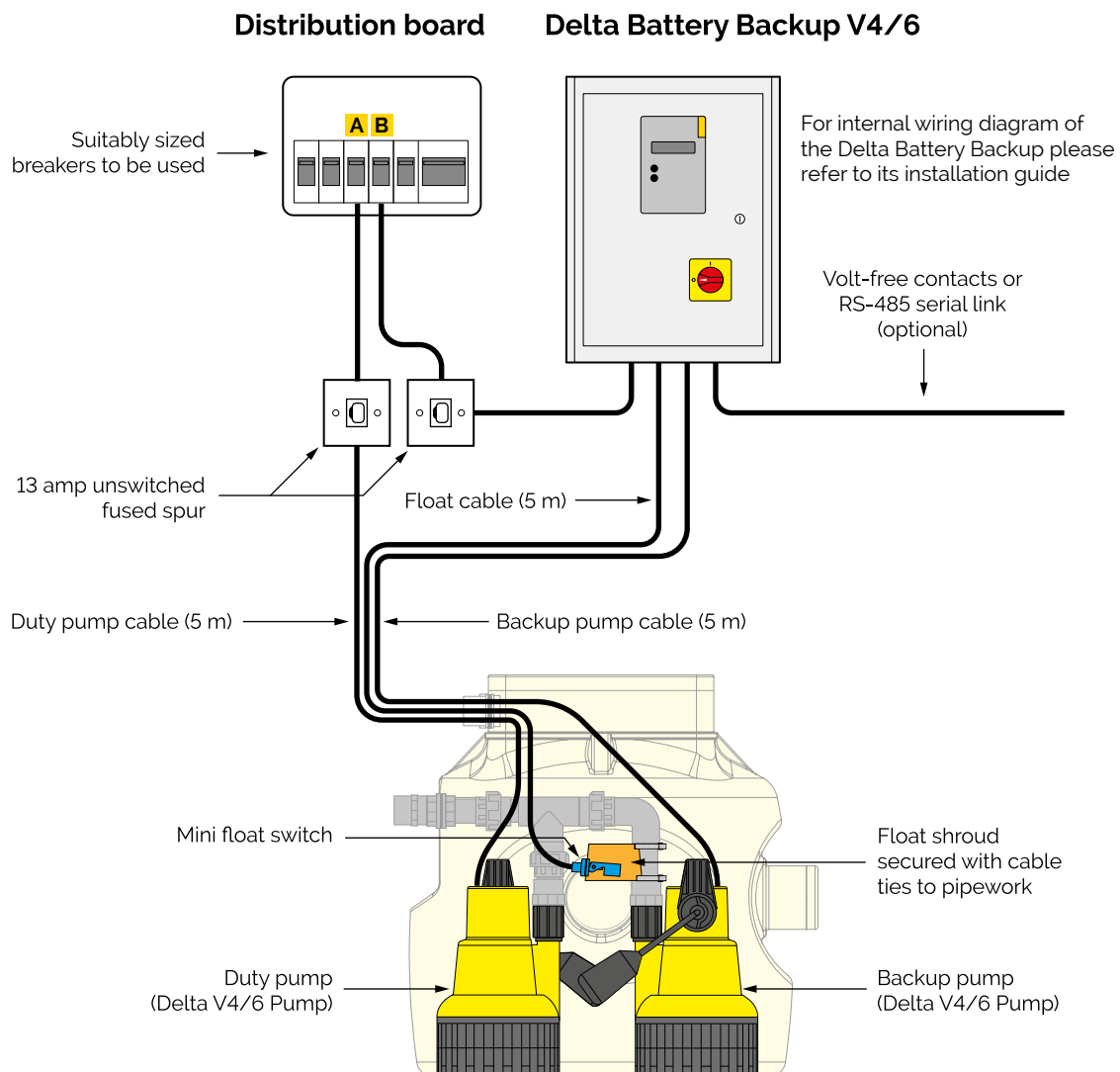

PACKAGED PUMPS

Delta Bespoke 800 Series Groundwater



Description

The Delta Bespoke 800 Series of Packaged Pumping Stations are available in depths from 1250mm to 2000mm and with varying pumping capabilities from the Delta Dual V3 to powerful Delta Dual V6 pump.

The robust and reliable Delta Bespoke 800 Series Packaged Pumping Station has been specifically designed to collect ground and surface water from basements, below ground structures.

Typical applications include (but are not limited to) Type C, Cavity Drained Waterproofing solutions and/or surface water from roofs, buried roofs, terraces and patios (subject to selection criteria).

Delta Bespoke 800 Series – system includes: a polyethylene chamber, 1¼" PVC internal pipework, two Delta V3, V4 or V6* sump pumps, 110mm inlet, 50mm cable duct, 110mm vent and 2" discharge.

This product is specifically designed for below ground applications where hydrostatic water pressure may be present. We recommend surrounding the Delta Bespoke 800 Series with concrete to prevent movement. An access cover is not supplied, as these are generally site specific and installed in the final finish. If required, the chamber will accept a standard 450mm x 600mm cover and frame. Inlets can easily be drilled and sealed on site, making this product straightforward to install.

The Delta Bespoke 800 Series - Groundwater is not suitable for collecting foul or grey water.

Product Details

Delta Dual V3

800-1250 Pump Station	DMS-E001
800-1500 Pump Station	DMS-E002
800-1750 Pump Station	DMS-E003
800-2000 Pump Station	DMS-E004

Delta Dual V4

800-1250 Pump Station	DMS-E005
800-1500 Pump Station	DMS-E006
800-1750 Pump Station	DMS-E007
800-2000 Pump Station	DMS-E008

Delta Dual V6

800-1250 Pump Station	DMS-E009
800-1500 Pump Station	DMS-E010
800-1750 Pump Station	DMS-E011
800-2000 Pump Station	DMS-E012



Delta Bespoke 800 Series Foul



Description

The Delta Bespoke 800 Series of Package Pumping Stations are available in depths from 1250mm to 2000mm.

The robust and reliable Delta Bespoke 800 Series - Foul Packaged Pump Station has been specifically designed to collect foul and/or grey water from basements, below ground structures and ground floor extensions or where foul water cannot be drained by gravity.

For kitchen applications we recommend fitting a grease trap prior to the pump station installation.

This product is specifically designed for below ground applications where hydrostatic water pressure may be present. However, we recommend surrounding the Delta Bespoke 800 Series - Foul with concrete to prevent movement. A manhole cover is not supplied as these are generally site specific and installed in the final finish.

The Delta 800 Series Foul Packaged Pumping Station can be installed at the initial building stage or retro fitting to existing buildings.

The Delta Bespoke 800 Series - V3 Foul is not suitable for collecting ground water from a cavity drained membrane system.

Product Details

Delta Single V3 Foul

800-1250 Pump Station	DMS-E013
800-1500 Pump Station	DMS-E014
800-1750 Pump Station	DMS-E015
800-2000 Pump Station	DMS-E016

Delta Dual V3 Foul (inc control panel)

800-1250 Pump Station	DMS-E017
800-1500 Pump Station	DMS-E018
800-1750 Pump Station	DMS-E019
800-2000 Pump Station	DMS-E020



DELTA 1000 SERIES - BBA PACKAGED PUMPING

Delta Pluto Package Pumping Station

Description

The Delta Pluto Packaged Pumping Station is available in association with TT Pumps and has been specifically designed to work in harmony with Cavity Drained Systems to collect Groundwater via a perimeter drainage channel or modular drainage.

This package pump station can withstand hydrostatic forces encountered in applications with high water tables. Pumping applications are invariably demanding – typically operating in unsympathetic, arduous, or extreme environments, where quality matters.

The powerful Delta Goliath/Delta Blue 50 (foul water) pump offers innovative design and advanced technology making it extremely dependable even when subjected to continuous use (subject to correct installation).

The Delta Pluto Packaged Pumping Station sump offers versatility of collecting water from external light-wells. The Delta Pluto packaged pump station includes chamber, all internal pipe work, valves and pumps. The Delta Pluto Packaged Pumping Station is suitable for collecting ground water from a 150m² basement and surface water from a maximum 12m² light well.

The extension turret is an innovative design that allows the installer to change the depth of the chamber installation to suit site specific levels. Due to possibility of site complications and changing requirements, it would be useful to be able to extend the depth of the tank. The extension turret is placed on top of the tank and clamped and sealed in place and can be cut at set increments to adjust the height of the pumping station chamber. The focus on this is to aid in reducing of installation time and to provide product flexibility in site conditions.

The Delta Pluto (150, 400, 550) Packaged Pumping Stations are not suitable for collecting foul water, for foul water applications the Delta Blue 50 should be specified.

Features

- BBA Approval and Accreditation
- Suitable for ground, surface, storm, and grey water applications
- Flow rate up to 7.5 l/s at up to 11m head
- Chamber manufactured from superior virgin tank grade HDPE enabling the Delta Pluto Packaged Pumping Station to withstand hydrostatic forces encountered in applications with high water tables
- Quick and simple installation
- 156 litre operating storage
- Supplied with Delta Goliath / Foul Blue 50 powerful Delta Pluto Pumps
- Suitable for residential, commercial and heritage projects



Specification

- BS 8102:2022 Protection of below ground structures against water ingress. Code of Practice
- NBS Specification R18 (Clause 310) Pumping Stations and Pressure Pipelines

Product Details

Delta Dual Pluto

150 including TT HLA Duty	DMS T001
400 including TT HLA Duty	DMS T002
550 including TT HLA Duty	DMS T003
Delta Pluto Dual Foul Blue 50 (including TT HLA Duty)	DMS T004
Delta Pluto Extension Turret (inc clamping kit and seal)	DMS T009



Delta Bespoke Mercury Foul



Description

The Delta 1000 Series - Mercury Foul Packaged Pumping Station is available in association with TT Pumps. The robust and reliable Delta 1000 Series - Mercury Series Packaged Pumping Station has been specifically designed and manufactured in the United Kingdom to provide an efficient and economical way of installing a sewage/drainage pumping station.

The extension turret is an innovative design that allows the installer to change the depth of the chamber installation to suit site specific levels. Due to possibility of site complications and changing requirements, it would be useful to be able to extend the depth of the tank. The extension turret is placed on top of the tank and clamped and sealed in place and can be cut at set increments to adjust the height of the pumping station chamber. The focus on this is to aid in reducing of installation time and to provide product flexibility in site conditions.

The Delta 1000 Series – Mercury Foul Package Pumping Station, is not suitable for collecting ground water from a cavity drained membrane system.

Features

- BBA Approval and Accreditation
- Pump chambers are well engineered and manufactured, and have passed rigorous and detailed testing, site inspections and factory production control assessment
- Each pump chamber is made of strong, medium-density polyethylene
- Smooth internal walls aid the hygienic disposal of effluents, to avoid smells and septicity.
- Comes complete with pipework pre-assembled in the chamber, ready for installation into the ground, after which the pumps and control equipment are added.
- All packaged pumping stations are supplied with controls for fully automatic operation, and a high-level alarm indicator
- Units can be adapted to suit individual requirements at manufacturing stage
- Packages are available on short lead-times to fit in with tight construction schedules.

Specification

- BS 8102:2022 Protection of below ground structures against water ingress. Code of Practice
- BS EN 10256-4:2000 Gravity drainage systems inside buildings - Wastewater lifting plants
- Construction (Design & Management) Regulations 2015
- Construction (Design & Management) Regulations (Northern Ireland) 2016

Product details

Mercury DGO 50	DMS T005
Mercury DGO 75	DMS T006
Mercury DGO 100	DMS T007
Mercury DGO 150	DMS T008
Extension Turret	DMS T010



TECHNICAL DRAWINGS

Type C Waterproofing Drainage

DRAINAGE CHANNEL IN SCREED INTO SUMP PUMP

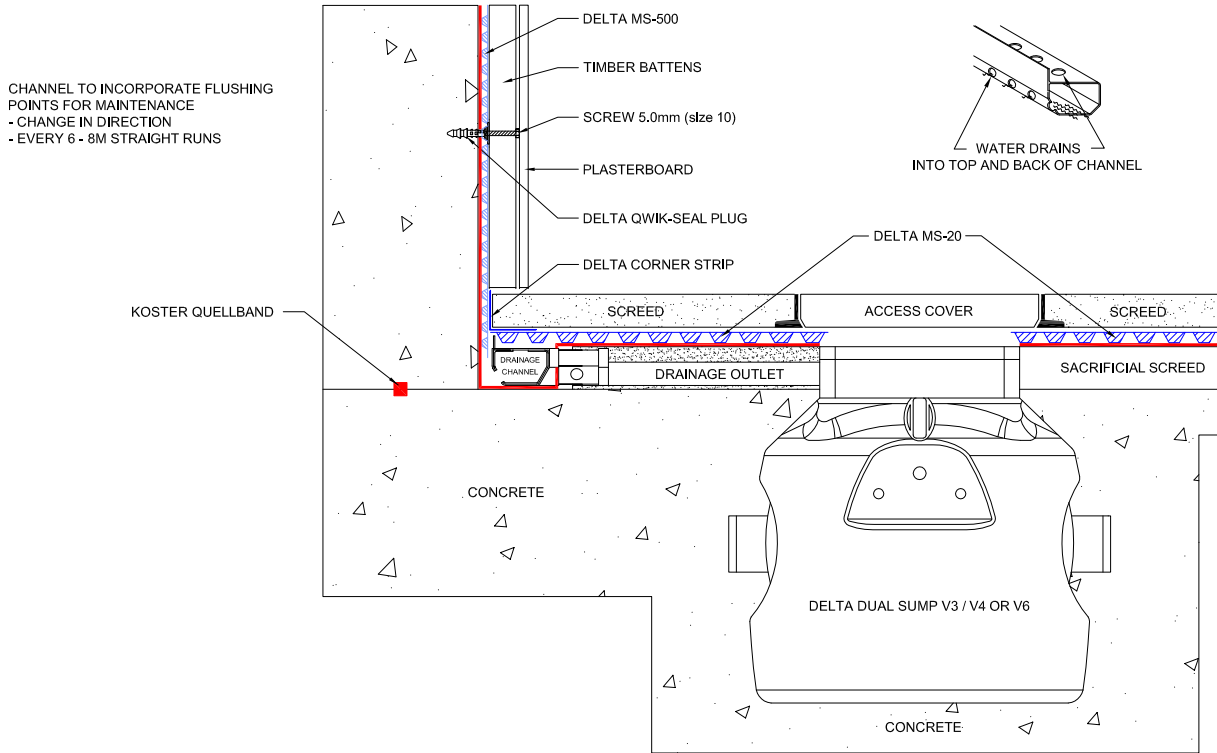

PAVEMENT VAULT

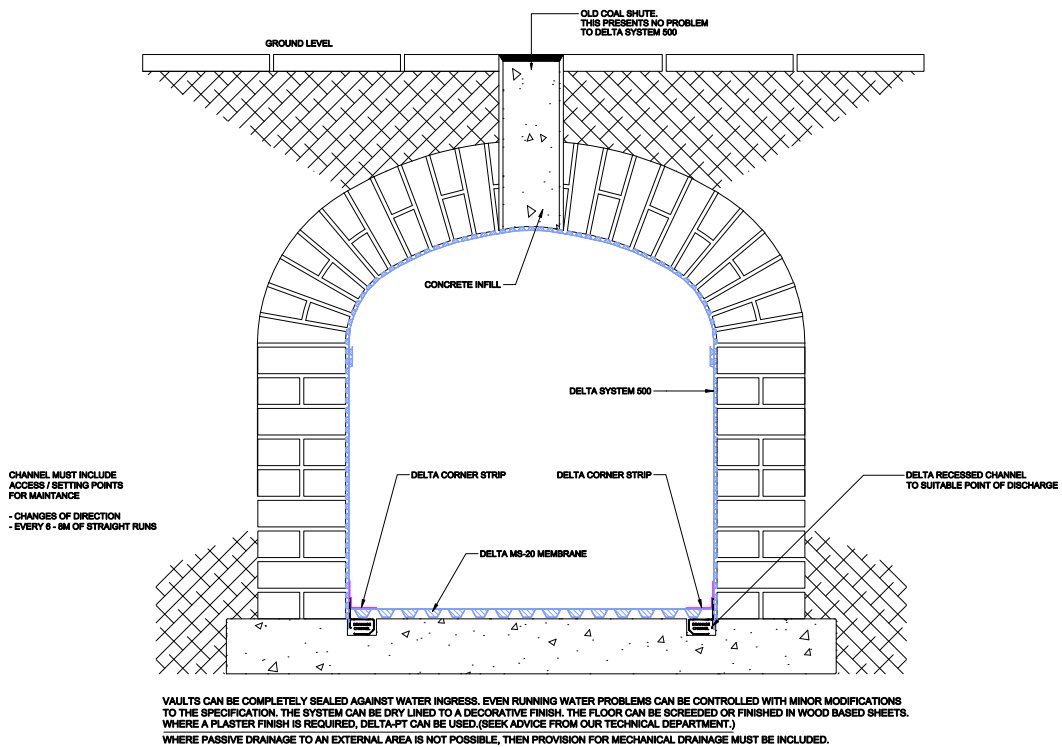

MS 500 - SHEET PILED WALLS - MODULAR SYSTEM

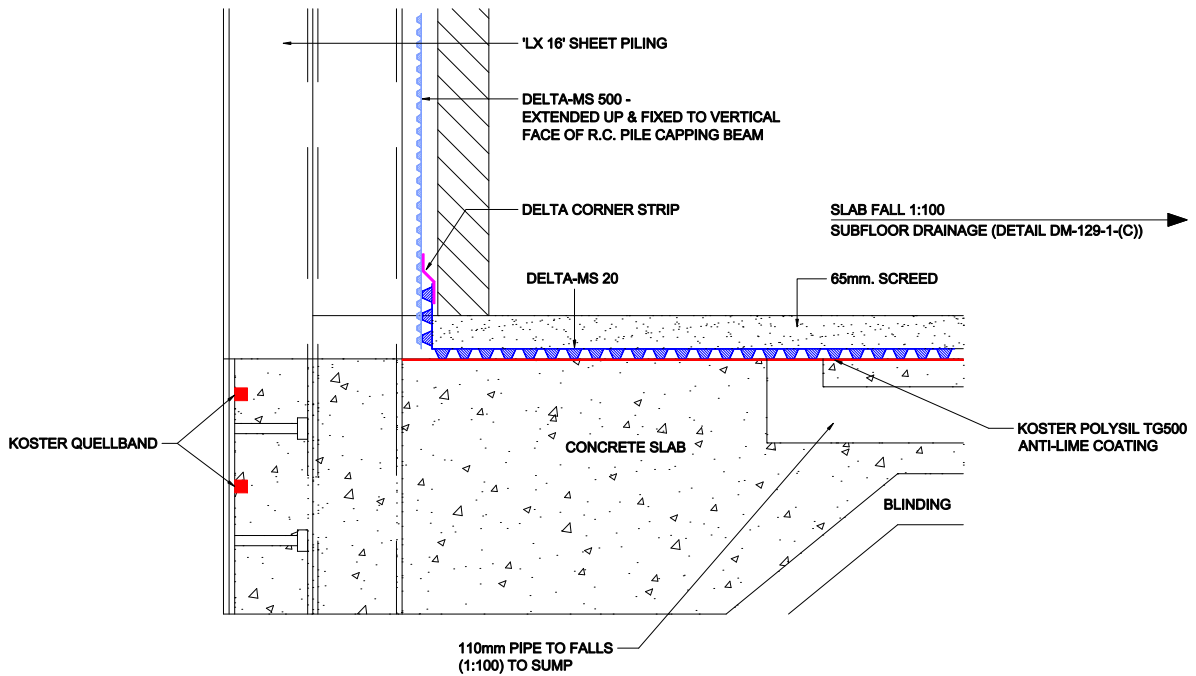

DELTA PT - WALL FINISH OPTIONS

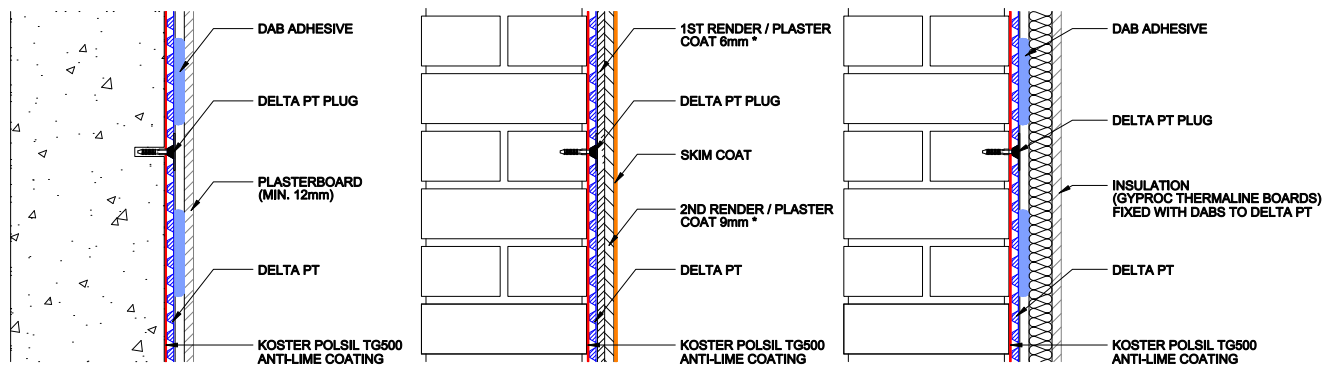

* RENDER: 1:1:6 CEMENT: LIME: SAND
 PLASTER: TARMAC WHITEWALL
 (FOR OTHER PROPRIETARY PLASTERS PLEASE CONTACT DELTA TECHNICAL)

TECHNICAL DRAWINGS

Type C Waterproofing Drainage

MID LEVEL BASEMENT - MID FLOOR DRAINAGE OPTION

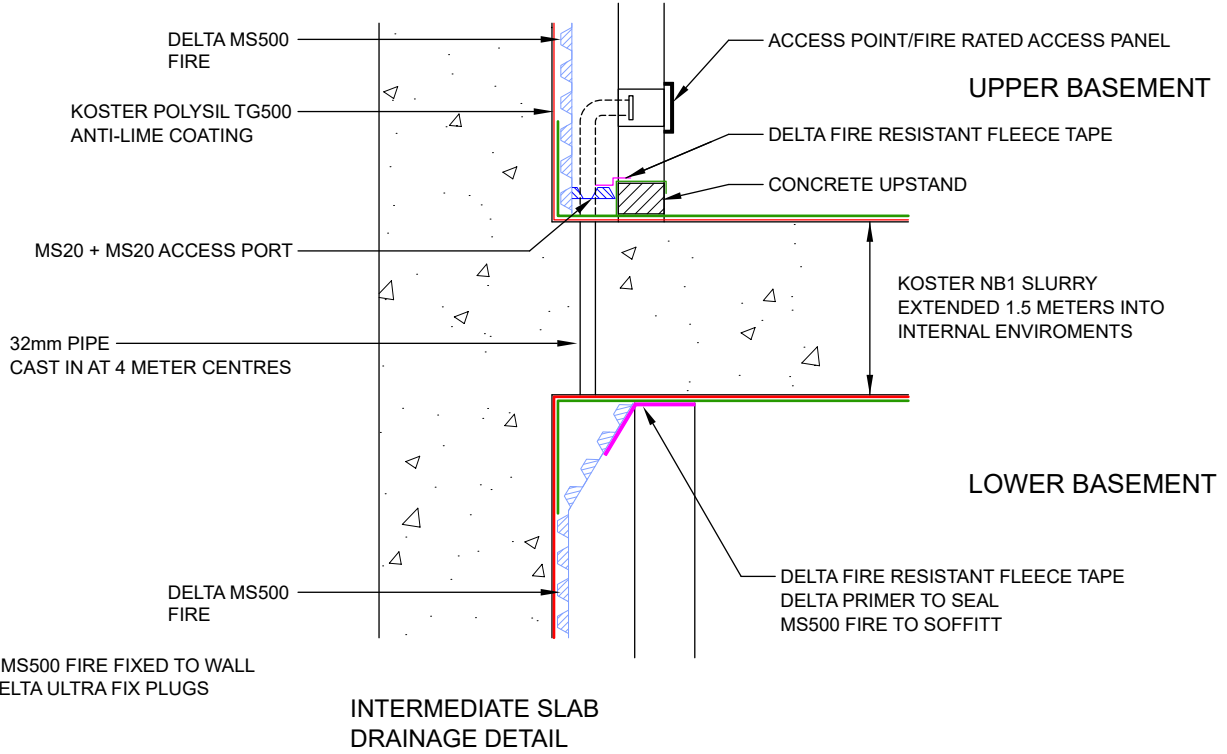

SACRIFICIAL SCREED

OPTION 1

DRAINED PROTECTION WALL AND FLOOR APPLICATION
- WITH DRAINAGE CHANNEL ON SLAB
SACRIFICIAL SCREED / T & G FLOOR PANELS

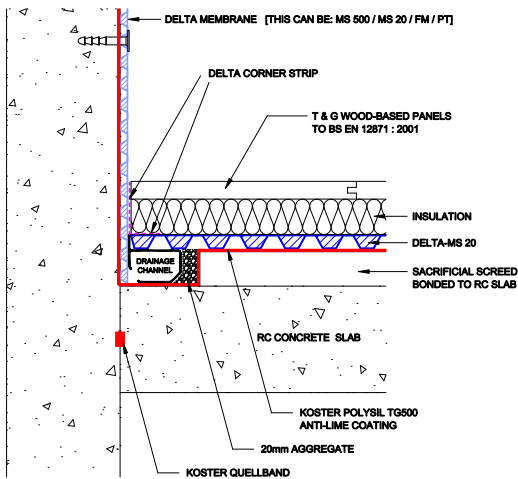

OPTION 2

DRAINED PROTECTION WALL AND FLOOR APPLICATION
- WITH DRAINAGE CHANNEL ON SLAB
SACRIFICIAL SCREED / SCREED FINISH

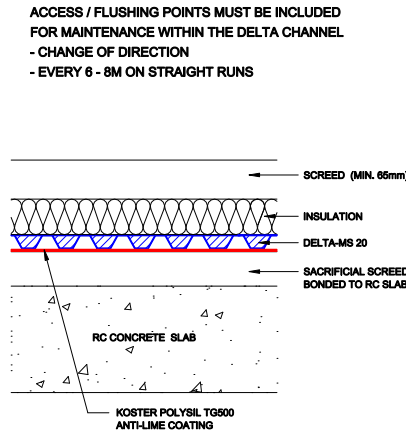

OPTION 3

DRAINED PROTECTION WALL AND FLOOR APPLICATION
- WITH DRAINAGE CHANNEL ON SLAB
SACRIFICIAL SCREED / SCREED WITH UNDERFLOOR HEATING

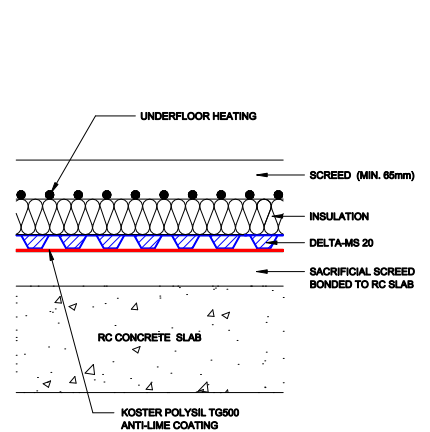

DELTA MS 500 / DELTA BOOT TO STEEL BEAM END

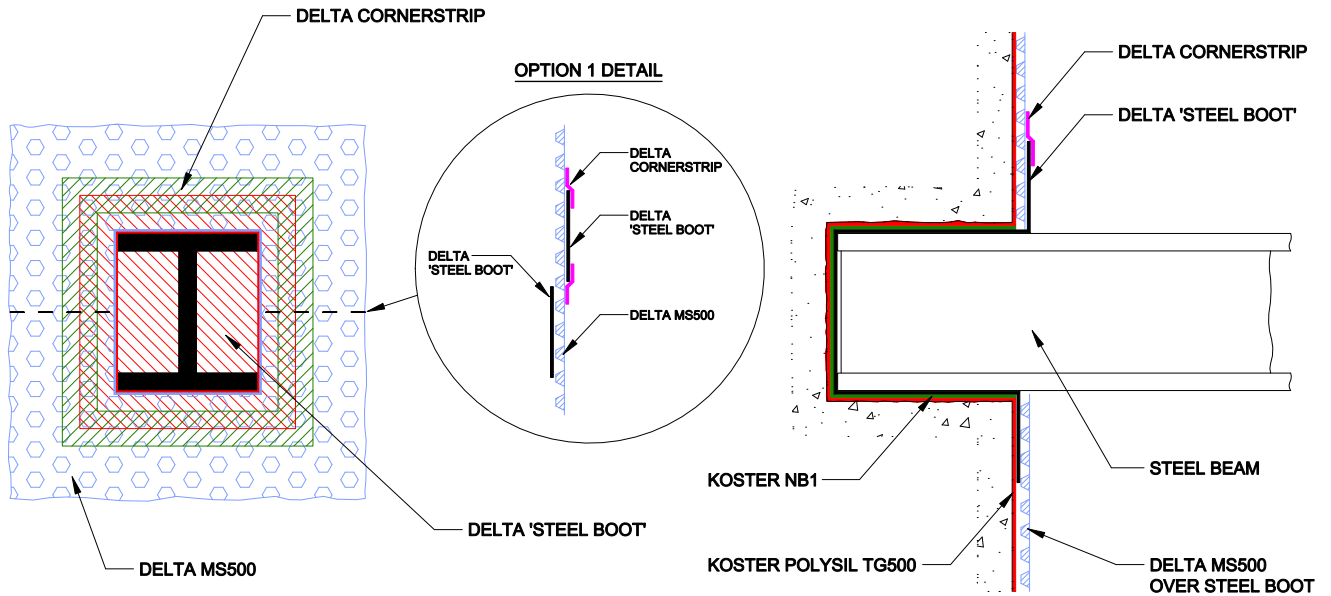

COMPLETE MODULAR SET UP DETAIL / + DELTA BATTERY BACK UP

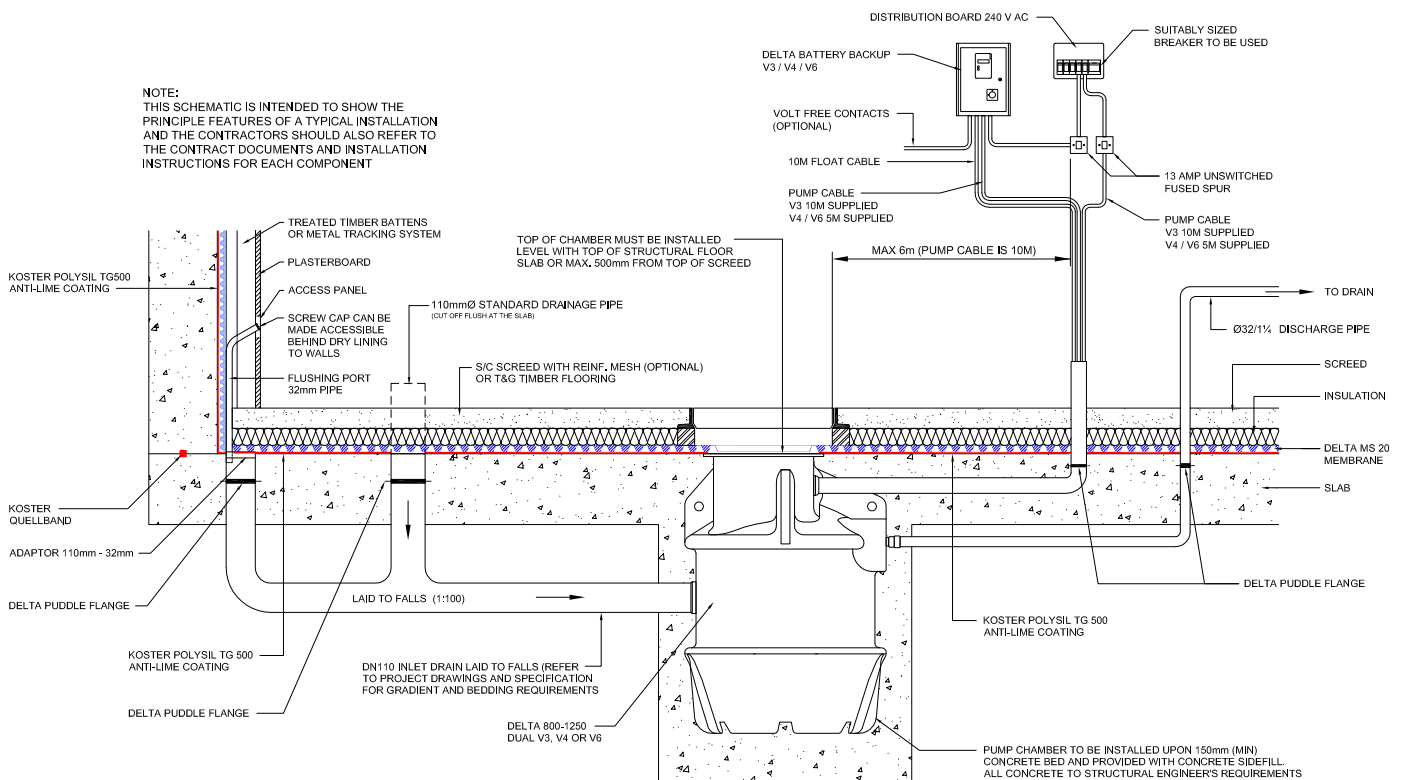

HEAD OFFICE

Delta House, Merlin Way, North Weald, Epping, Essex, CM16 6HR
01992 523 523 | info@deltamembranes.com | www.deltamembranes.com